

RADIO'S LIVEST MAGAZINE

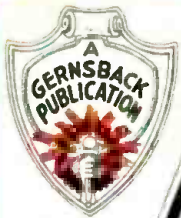

November  
**25 Cents**  
Canada 30¢

# Radio-Craft



**HUGO GERNSBACK** Editor

## Experiments in Radio Psychometry

See Page 264

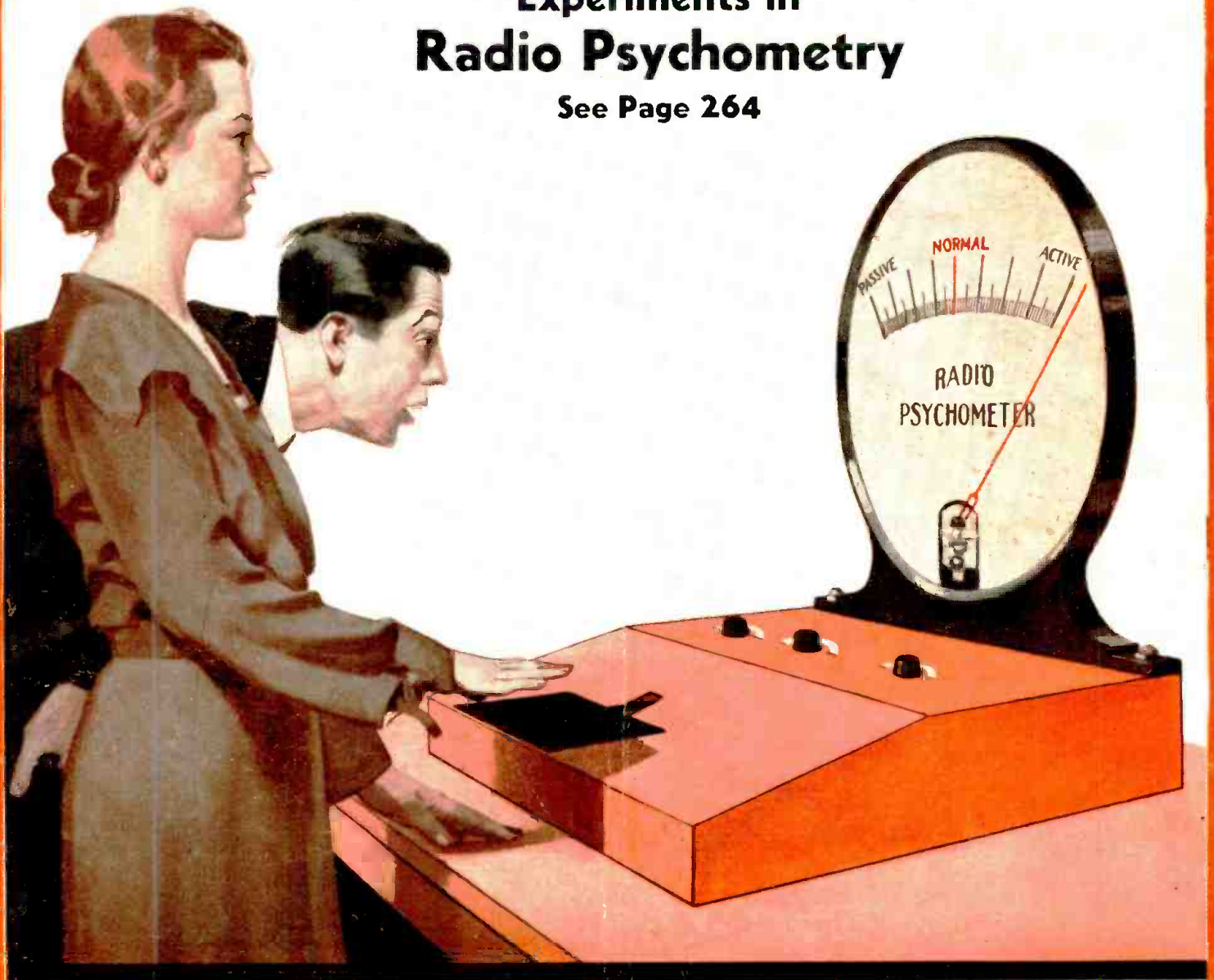

**Broadcast Station List – A Home Radio Robot – The "Resonator" Loudspeaker  
Making Transformers and Chokes – "Dry Cell" Tubes in A.C.-D.C. Receivers**

# READRITE EQUIPMENT APPROVED

## BY PROFESSION ...

*because of  
Greater Flexibility  
... Economy ... and  
Ruggedness*



**No. 710  
READRITE TESTER**

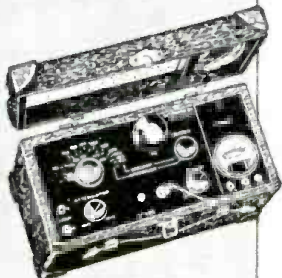

**No. 550  
READRITE  
OSCILLATOR**



**No. 410  
TUBE TESTER**

**N**OW is the time to cash in on the widespread public interest that is being aroused by the sensational Radio Prosperity Campaign. And you, as a Radio Service Engineer, can cash in best by using the Readrite testers shown here. They will make money for you and save you money! You can afford to standardize on Readrite instruments. They are popularly priced. They enable you to make more calls at less cost per call . . . they make it easy for you to meet every servicing requirement . . . they withstand the hardest kind of use and abuse . . . they insure that your equipment dollar stretches much farther.

### No. 710 READRITE TESTER

This all-purpose tester fills every need of both the expert service man and the beginner. It is designed for the testing of new and old radios. Equipped with a practical selector switch for checking all parts of tube circuits by connecting to the set sockets. Selection for testing voltage of plate, grid, cathode, suppressor grid and screen grid is quickly and accurately done. Plate current, filament volts, line and power supply volts, resistance and continuity are measured. Battery is used for continuity testing of transformers, chokes, etc. Handles most advanced circuits and newest tubes.

The No. 711 Readrite Tester is the same as the No. 710 except that it is equipped with the new Triplett D'Arsonval Volt-ohmmeter, which has 1000 ohms per volt resistance. The readings are 0-15-60-300-600---0 to 300,000 ohms. Ohmmeter reading is secured with the 4½ volt battery, which is furnished.

### No. 550 READRITE OSCILLATOR

This signal generator furnishes a modulated signal of constant frequency for the alignment of all modern radios. It is used to align r. f. transformers, check oscillator stage, compare gain in tubes and determine the sensitivity of a receiver.

### No. 410 TUBE TESTER

Used for checking new and old tubes in receiving sets. Simply designed, compactly constructed, this tester is ideal for both outside work and for counter use. A push button provides two-plate current readings for determining the conductance and worth of a tube. For those wanting a longer-scale instrument, the Model 416 Tester, with a Triplett D'Arsonval Flush Mounted Meter is offered. This instrument does not have illuminated dial, but in other respects is the same as the No. 410.

#### YOUR JOBBER CAN SUPPLY YOU

See him today, or send the coupon for descriptive catalog.

## READRITE METER WORKS

81 College Ave., Bluffton, Ohio



Here's  
Proof of  
READRITE  
Leadership.

Write  
for your  
copy  
TODAY!



TIE IN  
WITH THE NEW  
PROSPERITY  
CAMPAIGN

**SEND COUPON  
FOR QUICK FACTS !**

READRITE METER WORKS,  
81 College Ave.,  
Bluffton, Ohio.

Gentlemen:  
Send me catalog on Readrite Instrument No. ( )  
as well as folder giving proofs of Readrite Leadership.

Name.....

Street Address.....

City..... State.....

# OPPORTUNITIES

*are many*

## for the Radio Trained Man

Don't spend your life slaving away in some dull, hopeless job! Don't be satisfied to work for a mere \$20 or \$30 a week. Let me show you how to get your start in Radio—the fastest-growing, biggest money-making game on earth.

### Jobs Leading to Salaries of \$50 a Week and Up

Prepare for jobs as Designer, Inspector and Tester—as Radio Salesman and in Service and Installation Work—as Operator or Manager of a Broadcasting Station—as Wireless Operator on a Ship or Airplane, or in Talking Picture or Sound Work—HUNDREDS OF OPPORTUNITIES for a real future in Radio!

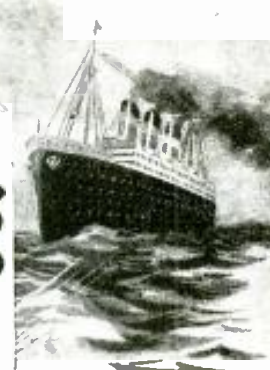
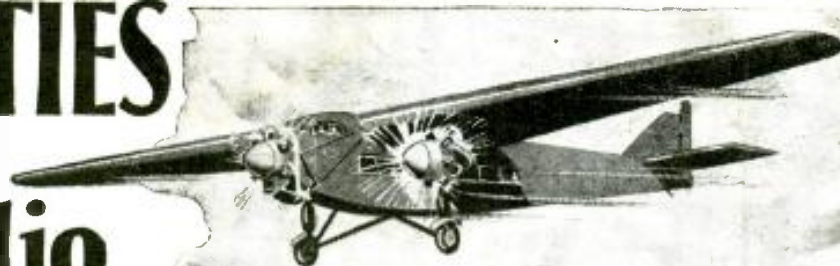

## Ten Weeks of Shop Training

Pay Your Tuition After Graduation

We don't teach by book study. We train you on a great outlay of Radio, Television and Sound equipment—on scores of modern Radio Receivers, huge Broadcasting equipment, the very latest and newest Television apparatus, Talking Picture and Sound Reproduction equipment, Code Practice equipment, etc. You don't need advanced education or previous experience. We give you—RIGHT HERE IN THE COYNE SHOPS—the actual practice and experience you'll need for your start in this great field. And because we cut out all useless theory and only give that which is necessary you get a practical training in 10 weeks.

## TELEVISION *and* TALKING PICTURES

And Television is already here! Soon there'll be a demand for THOUSANDS of TELEVISION EXPERTS! The man who learns Television now can have a great future in this great new field. Get in on the ground-floor of this amazing new Radio development! Come to COYNE and learn Television on the very latest, newest Television equipment. Talking Picture and Public Address Systems offer opportunities to the Trained Radio Man. Here is a great new Radio field just beginning to grow! Prepare NOW for these wonderful opportunities! Learn Radio Sound Work at COYNE on actual Talking Picture and Sound Reproduction equipment.

### PAY FOR YOUR TRAINING After You Graduate

I am making an offer that no other school has dared to do. I'll take you here in my shops and give you this training and you pay your tuition after you have graduated. Two months after you complete my course you make your first payment, and then you have ten months to complete your payments. There are no strings to this offer. I know a lot of honest fellows haven't got a lot of money these days, but still want to prepare themselves for a real job so they won't have to worry about hard times or lay offs.

I've got enough confidence in these fellows and in my training to give them the training they need and pay me back after they have their training.

If you who read this advertisement are really interested in your future here is the chance of a life time. Mail the coupon today and I'll give you all the facts.

### ALL PRACTICAL WORK At COYNE in Chicago

ALL ACTUAL, PRACTICAL WORK. You build radio sets, install and service them. You actually operate great Broadcasting equipment. You construct Television Receiving Sets and actually transmit your own Television programs over our modern Television equipment. You work on real Talking Picture machines and Sound equipment. You learn Wireless Operating on actual Code Practice apparatus. We

don't waste time on useless theory. We give you the practical training you'll need—in 10 short, pleasant weeks.

### MANY EARN WHILE LEARNING

You get Free Employment Service for Life. And don't let lack of money stop you. Many of our students make all or a good part of their living expenses while going to school and if you should need this help just write to me. Coyne is 33 years old. Coyne Training is tested—proven beyond all doubt. You can find out everything absolutely free. Just mail coupon for my big free book!

H. C. Lewis, Pres. RADIO DIVISION Founded 1899

## COYNE Electrical School

500 S. Paulina St., Dept. 83-8H, Chicago, Ill.

Mail Coupon Today for All the Facts

H. C. LEWIS, President

Radio Division, Coyne Electrical School  
500 S. Paulina St., Dept. 83-8H, Chicago, Ill.

Dear Mr. Lewis:— Send me your Big Free Radio Book, and all details of your Special Offer.

Name .....

Address .....

City ..... State .....



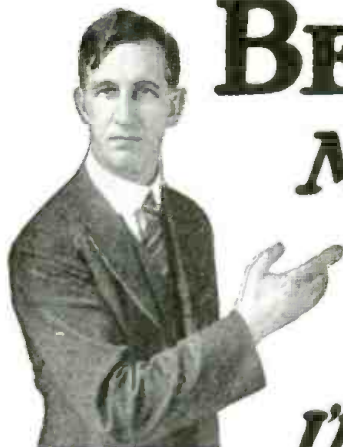

J. E. Smith, President, National Radio Institute, the man who has directed the Home-Study training of more men for the Radio Industry than any other man in America.

# BE A RADIO EXPERT

## Many Make

# \$40 \$60 \$75

## a Week

*I'll Train You at Home in Your Spare Time*  
**for RADIO · TELEVISION · TALKING MOVIES**



**Set Servicing**  
 Spare-time set servicing pays many N. R. I. men \$5, \$10, \$15 a week extra. Full-time men make as much as \$40, \$60, \$75 a week.

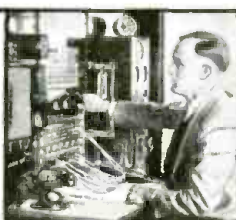

**Broadcasting Stations**

Employ managers, engineers, operators, installation and maintenance men for jobs paying up to \$5,000 a year.

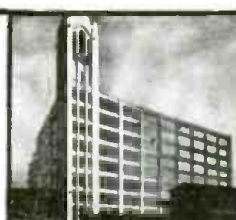

**Radio Factories**

Employ testers, inspectors, foremen, engineers, servicemen, for jobs paying up to \$7,500 a year.

**Aircraft Radio**

Radio is making flying safer. Radio operators employed through Civil Service Commission earn \$1,620 to \$2,800 a year.



**Talking Movies**

An invention made possible by Radio. Employs many well-trained Radio men for jobs paying \$75 to \$200 a week.



**Television**

The coming field of many great opportunities is covered by my course.



If you are dissatisfied with your present job; if you are struggling along in a rut with little or no prospect of anything better than a skimpy pay envelope—fill the coupon NOW. Get my big FREE book on the opportunities in Radio. Read how quickly you can learn at home in your spare time to be a Radio Expert—what good jobs my graduates have been getting—real jobs with real futures.

**Many Radio Experts Make \$40, \$60, \$75 a Week**

In about ten years the Radio Industry has grown from a few million dollars to hundreds of millions annually. Over 300,000 jobs have been created by this growth, and thousands more will be created by its continued development. Many men and young men with the right training—the kind of training I give you in the N. R. I. Course—have stepped into Radio at two and three times their former salaries.

**Real Opportunities Ahead in Radio for Trained Men**

It's hard to find a field with more opportunity awaiting the trained man. Why in 1932—the worst year of the depression—the Radio Industry sold \$200,000,000 worth of sets and parts! Manufacturers alone employed nearly 100,000 people! About 300,000 people worked in the industry. In 1932, broadcasting had its most profitable year. It's a gigantic business, even in the worst business years! And look what's ahead! Millions of sets becoming obsolete annually. 17,000,000 sets in operation that need servicing from time to time! Over 600 great broadcasting stations furnishing entertainment and news to 100,000,000 people. These figures are so big that they are hard to grasp! Yet, they are all true! Here is a new industry that has grown quickly into a commercial giant. No wonder great business leaders predict a brilliant future for this great and growing business.

**Get Into This Field With a Future**

There's opportunity for you in Radio. Its future is certain. Television, short wave, police Radio, automobile Radio, midket sets, loud speaker systems, aircraft Radio—in every branch, developments

and improvements are taking place. Here is a real future for thousands and thousands of men who really know Radio. Get the training that opens the road to good pay and success! Send the coupon now and get full particulars on how easy and interesting I make learning at home. Read the letters from graduates who are today earning good money in this fascinating industry.

**Many Make \$5, \$10, \$15 a Week Extra in Spare Time Almost at Once**

My book also tells how many of my students made \$5, \$10 and \$15 a week extra servicing sets in spare time, soon after they enrolled. I give you plans and ideas that have made good spare-time money—\$200 to \$1,000 a year—for hundreds of fellows. My Course is famous as "the one that pays for itself."

**Money Back if Not Satisfied**

I am so sure that N. R. I. can train you at home satisfactorily that I will agree in writing to refund every penny of your tuition if you are not satisfied with my Lessons and Instruction Service upon completion. You'll get a copy of this Agreement with my book.

**64-page Book of Information Free**

Get your copy today. It's free to any ambitious fellow over 15 years old. It tells you about Radio's spare-time and full-time job opportunities; it tells you all about my Course; what others who have taken it are doing and making. Find out what Radio offers YOU without the slightest obligation. MAIL THE COUPON NOW.

J. E. SMITH, President  
 National Radio Institute  
 Dept. 3MX  
 Washington, D. C.



**28 MONEY MAKING HINTS FREE**

Mail the coupon. I'll send you one copy of my valuable 56-page Reference Book "28 Tested Methods for Making Extra Money." I'll do it to prove that my training is easy to understand and use—that it is practical—that it is full of money-making information right from the start. This book shows you how to do 28 Radio jobs common in every neighborhood—tells you how to get these jobs. Hundreds of my students have made \$5, \$10, \$15 a week in spare time while learning. Prove to yourself that you can do it too. Mail coupon now.



**THIS COUPON IS GOOD for**  
**One FREE COPY OF** *mail it now*  
**MY BOOK**

J. E. Smith, President  
 National Radio Institute, Dept. 3MX  
 Washington, D. C.

Dear Mr. Smith: I want to take advantage of your Special Offer. Send me your two books, "28 Tested Methods for Making Extra Money" and "Rich Rewards in Radio." I understand this does not obligate me.  
 (PLEASE PRINT PLAINLY)

Name ..... Age.....  
 Address .....  
 City ..... State.....

113-1



# YOUR COPY OF THE 1934

# OFFICIAL RADIO SERVICE MANUAL IS READY!



THE necessity of GERNSBACK Manuals in the radio field has been shown by the fact that the total sales of the first three OFFICIAL RADIO SERVICE MANUALS, including the new CONSOLIDATED EDITION, now exceed 80,000 copies.

Radio Service Men and others engaged in various branches of radio know the importance of such books, and how they must depend upon them for reliable information. Whether for public-address work, tube information or a circuit diagram, the material needed is certain to be found in one of the OFFICIAL RADIO SERVICE MANUALS. The GERNSBACK Manuals have been constantly used in reference work by leading radio set manufacturers, mail-order houses, jobbers, dealers and, most extensively, by Service Men, for whom these books are invaluable.

In the planning of the 1934 OFFICIAL RADIO SERVICE MANUAL many things have been taken into consideration. First, how we could reduce our own costs, and in turn pass these savings on to our readers. Second, what information not contained in previous editions of the Manuals must be incorporated in the 1934 edition and would be of utmost importance to its users. Third, what advance information we could print that would be useful in the future.

After careful analysis we found that the total cost of producing the 1934 Manual would be considerably less than in former years, and that at this time we could reduce the price of the book to our readers. The Fourth Edition of the OFFICIAL RADIO SERVICE MANUAL will sell this year for \$3.50. The book will be published like the 1933 Manual—the volume will be sent to you complete. As usual, we urge that all our readers place their order early so that they will get a copy of the first printing. Usually, at the last minute a tremendous number of orders come to us and quite often orders are held up while the book is going through a second printing.

In preparing this new edition many of the outstanding problems of the Service Men have been considered—methods of servicing, the new equipment constantly needed to cope with new tubes and sets, and the other fields of radio, such as public-address systems, short waves, auto radio and others.

As in previous years, the 1934 Manual will also include a FREE QUESTION AND ANSWER SERVICE. In each book will be found 25 coupons, which entitle you to free consultation on any radio service topics. These coupons give you a complete mail service—questions on servicing and operating on any set or circuit

are answered promptly and accurately by the editors. Remember that, at the regular rate of 25c per question which is usually charged by radio magazines, this service alone is worth \$6.00. And for the Manual, we charge only \$3.50.

It is quite evident that the 1934 Edition of the OFFICIAL RADIO SERVICE MANUAL will be a decided improvement over previous volumes, and will even surpass the high standard of the former Manuals.

### ORDER YOUR COPIES NOW

It is important to every Radio Service Man and Dealer that he receive his copy of the 1934 OFFICIAL RADIO SERVICE MANUAL as soon as it is published. The new book will prove itself to be invaluable as those volumes of previous years. The book as usual comes to you postpaid and free of additional charges.

No need to delay sending us your order—the 1934 MANUAL, like its predecessors, is a necessity in your business. We strongly advise you to order your copy today, and then you will be certain to get one from the first printing of the book. The 1934 Manual is now ready for delivery.

Mail the coupon today.

### Contents of the 1934 Manual in Brief

- Diagrams and service notes, more complete than ever before in any MANUAL. Not merely the schematic hook-ups will be found, but also chassis drawings showing parts layouts, positions of trimmers, neutralizers, etc.
- Voltage readings for practically all sets, as an aid in checking tubes and wiring.
- All values of intermediate-frequency transformers used in superheterodynes, with the manufacturers' own suggestions as to correct balancing.
- Detailed trouble-shooting suggestions and procedure as outlined by the manufacturers' own engineers—in other words, authentic "dope" right from headquarters.
- Values of all parts indicated directly on all diagrams. WE WILL POSITIVELY NOT INCLUDE DIAGRAMS FOR WHICH PARTS VALUES CANNOT BE OBTAINED.
- A special section for reference to A.C.-D.C. cigarbox midgets.
- A special section for reference to automobile radio.
- A special section for reference to public-address amplifiers.
- A special section for reference to short-wave receivers.
- A special section for reference to remote-control systems.
- A complete compilation of radio tube data, covering both the old and the many new types.
- A special section devoted to test equipment, analyzers, etc., with full diagrams and other valuable information.
- A complete list of American broadcast stations with their frequencies in kilocycles; extremely useful in calibrating and checking test oscillators and in calibrating receivers.
- Free Question and Answer Service, the same as in our last two Manuals.
- No theory; only service information in quickly accessible form.
- Absolutely no duplication of any diagrams; nothing that appeared in any of the previous Manuals will appear in the 1934 MANUAL. This we unconditionally guarantee.
- A handy, easily-consulted master Index making it easy for you to find almost anything pertaining to your service problem instantly. This index will include all the diagrams published in all the previous GERNSBACK Manuals, as well as the 1934 diagrams. A big convenience and time saver!

The illustrations in the 1934 Manual will be more explicit than before; inasmuch as the diagrams will not be limited to the schematic circuit, but other illustrations will show the parts layout, positions of trimmers, neutralizers, etc. There will be hundreds of new circuits included, and not one from any previous edition of the manuals will be repeated. *This we unconditionally guarantee.*

The number of pages in the new Manual will exceed 400, with hundreds of illustrations, including diagrams, charts, photos, picture layouts, etc. The size of the Manual will be the same as that of the former volumes—9x12 inches, with a flexible, loose-leaf binder.

**GERNSBACK PUBLICATIONS, Inc.**  
96-98 Park Place, New York, N. Y.

Gentlemen: Enclosed you will find my remittance of \$3.50 for which you are to send me One Copy of the 1934 OFFICIAL RADIO SERVICE MANUAL as soon as it comes off the press. [Send remittance by check or money order; or register letter if it contains cash, currency or unused U. S. Postage stamps.]

Name.....

Address.....

City..... State.....

RC-1133



... say these **30**  
**Leading Radio Manufacturers**  
 . . to their **40,000**  
**DISTRIBUTORS**  
 and **DEALERS**  
 throughout United States  
 and Canada

- AMERICAN BOSCH
- AMERICAN TELEVISION
- ARCTURUS TUBES
- BALKEIT • BRUNSWICK
- CAPEHART
- CLOUGH-BREngle CO.
- CROSLY • CLARION
- DAYRAD • DeFOREST
- ECHOPHONE
- FADA • GREBE • HOWARD
- HAMMERLUND
- KENNEDY • KOLSTER • LYRIC
- MAJESTIC • PHILCO
- SANGAMO ELECTRIC
- SENTINEL • SHELDON
- SILVER-MARSHALL
- STEWART HALL
- STEWART-WARNER
- STROMBERG-CARLSON
- UNIVERSAL MICROPHONE
- ZENITH

The need for men, PROPERLY trained, is one of the Radio Industry's major problems, today.

In fact, the very future of the Radio Industry is dependent on the industry having available, at all times, an adequate supply of PROPERLY trained men to install and service—not only the present-day highly complicated Radio and Electronic equipment—but the still more complicated equipment that will be brought out by the Industry, from time to time.

The above 30 manufacturers realize this. They know that under such circumstances, no ordinary Radio Training is going to give them the type of "trained" man they want. Only a Training that is right-up-to-the-minute, and properly prepared, highly practical, and properly supervised, will answer their purpose.

Radio and Television Institute home-training has successfully met their every test. That's why these manufacturers recommend R. T. I. Training, not only to their own men, everywhere—but to all men who want to get somewhere in Radio.

*This message approved by the above thirty Radio Manufacturers.*  
 Copyright 1933 by R.T.I.

# LEARN RADIO FROM REAL RADIO ENGINEERS



LET THESE ENGINEERS RIGHT FROM THE HEART OF THE BIG RADIO INDUSTRY Train You at Home for

## GOOD PAY RADIO WORK

To the man who wants to make \$35 to \$75 a week and more—Here's a Message for You!

*"The great Radio Industry, today—more than ever before—is on the lookout for PROPERLY trained men to fill its more responsible jobs. These are the better-paying jobs in Radio... jobs which give steady work at good pay, as a starter; and an early advancement to still better-paying jobs, as a future."*

### HERE, THEN, IS REAL OPPORTUNITY

But to qualify for these better-paying jobs, men must be PROPERLY "trained"—they must know the theory of Radio, as well as the practical side, and be able to teach other men some of the things they know.

The Radio Industry, itself, has no time to train these men. That's why the Radio & Television Institute, of Chicago, is doing the job. You'll be trained at home—in your spare time—easily and quickly, and at a cost of only a few cents a day. And as you are taught to "earn as you learn"—R. T. I. Training need cost you nothing.

### R.T.I. TRAINING IS "SHOP TRAINING" FOR THE HOME

It comes to you right from the Radio Industry—right out of the factories where Radio sets and other vacuum-tube devices are made. It was planned and prepared for you by big radio engineers IN these factories, most of whom are the Chief Engineers of these great Radio plants. And NOW these same engineers are actually supervising R. T. I. Training. Which means that trained the R.T.I. way, you'll be trained as the Radio Industry wants you trained—just as the Radio Industry, itself, would train you if it was doing the job.

You learn by doing, of course, because that's the Shop Way of teaching. But you also learn the theory of Radio—without which you can't hope to go far, or make much money, in this great industry.

**ELECTRONICS—SOUND PICTURES**  
**P. A. SYSTEMS—PHOTO CELLS—**  
**TELEVISION—all included**

Radio service is just the starting point in R.T.I. Training. From there we take you up through the very latest developments in Radio, and

**HERE THEY ARE:**

Dr. C. M. Blackburn,  
 Chief Radio Engineer,  
 Grigsby-Grunow Company  
 (Majestic).  
 Kendall Clough, Chief Engineer  
 Clough-Brengle Co. (Radio  
 Engineers and Manufacturers)  
 Karl Hassel, Chief Engineer,  
 Zenith Radio Corporation,  
 Homer Hogan, Gen. Manager,  
 Radio Station WYV, Chicago.  
 R. MacGregor, Service Manager  
 and Sales Engineer,  
 Transformer Corporation of  
 America (Clarion).  
 H. C. Tittle, Chief Radio Engr.,  
 Stewart-Warner Corporation,  
 F. D. Whitten, Service Manager,  
 Chicago Plant,  
 Philco Radio and Television  
 Corporation,  
 —and R.T.I. Staff.

then on into the new and larger field of Electronics—Sound Pictures, Public Address Systems, Photo Cells, and Television. This feature alone makes R. T. I. the outstanding home training in Radio.

### YOU GET "QUICK RESULTS"

C. E. Head, 431 Third St., Alexandria, La., Says: "Made my first money 11 days after starting your training—cleared \$14.25."

Frank E. Klemann, Lisle, Ill., writes: "Doubled my pay in less than six months."

Harry L. Stark, Ft. Wayne, Ind., writes: "Now making three times as much money as I was making when I started your training."

So, if you want to get out of a small pay, no-future job, and into good pay, big-future work—get into Radio. But let these big engineers direct your training.



### MAIL COUPON FOR FREE BOOK

Let me tell you more about this amazingly easy Shop-Type home-training, and more about the wonderful opportunities for the R. T. I. TRAINED man in this

growing industry. Everything is fully explained in my big, new booklet... "RADIO'S FUTURE, AND YOURS." Send today for your copy. The book is free.

Ray D. Smith, President,  
 Dept. 68 Radio and Television Institute, Chicago

Ray D. Smith, President,  
 RADIO and TELEVISION INSTITUTE, (R.T.I.),  
 2130 Lawrence Ave., Dept 68 Chicago, Ill.

Without obligation of any kind please send me a copy of "Radio's Future and Yours." I am interested in your home training and the opportunities you say exist in the great field of Radio for the R.T.I. Trained man.

Name.....  
 Address.....  
 City..... State.....



# Radio's GREATEST Servicing Book

*The Most Complete Directory of Radio Circuit Diagrams published!*

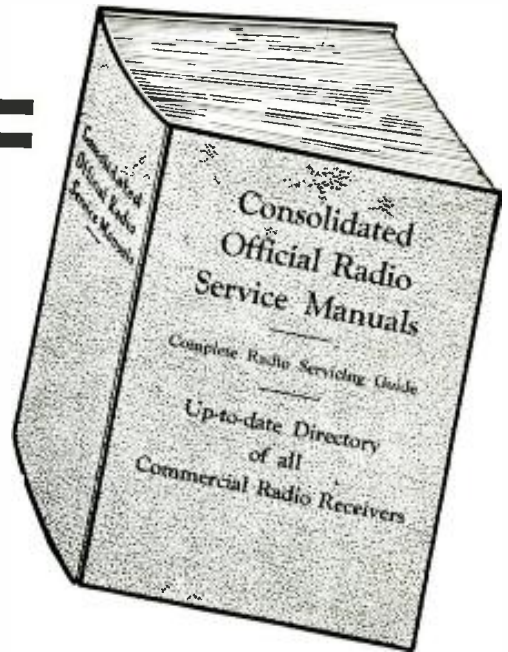

**In ONE VOLUME of over 2,300 Pages**  
**Extra Heavy Cover—Looseleaf Bound**

Buy this Big Volume on our *New*  
**DEFERRED PAYMENT PLAN**

Here are two of the most surprising announcements that we have ever made to the radio trade and we know that it is such good news that every radio man will be greatly enthused. **FIRST**—that the three editions of the OFFICIAL RADIO SERVICE MANUALS have now been combined into one big volume of over 2,300 pages. **SECOND**—that this new single volume of consolidated radio circuit diagrams and complete radio servicing course can be bought on a deferred payment plan—and at a big saving. It is needless to say how valuable the OFFICIAL RADIO SERVICE MANUALS have been to members in every branch of the Radio Industry, and how many thousands of each edition have been sold to manufacturers, jobbers, dealers, Service Men and experimenters. But we must emphasize this one fact: Service Men now realize that they are tremendously handicapped without the full set of Gernsback Manuals. So much so, that those who have purchased only one or two volumes, are NOW ORDERING THE MISSING BOOKS. They want their files to be complete. The complete book gives you a volume of over 2,300 pages with over 5,500 diagrams, charts and photos. There are absolutely no pages or illustrations or diagrams duplicated. There is no radio book published today which is so mod-

ern, up-to-the-minute, and which contains so much useful information as is to be found in this single volume. It is a book that will outlast any other radio book in print. Look carefully at the illustration of the complete edition on the top of page. It measures 9" wide, 12" long, 4 1/2" thick. Included in this volume is a complete radio servicing course. This course covers every step needed to learn the servicing business . . . from starting in business . . . materials needed . . . and how to go about servicing receivers and repairing other radio equipment. This course in itself, is actually worth the price of the entire book. Our new plan now enables every radio man to get this single volume—a Complete Directory of all Circuit Diagrams, of over 2,300 pages, on deferred payments. You can order this book immediately—get it in a few days, and use it while you are doing servicing work. You can make the first few calls pay for the entire cost of the book. For you to get this book is quite simple and it is sent to you as soon as your order is received. You pay for it in small monthly amounts which can be taken from your earnings. If you were to buy the three volumes separately, the total cost would be \$17.00, including the supplements.

Now you can get the  
 1931 OFFICIAL RADIO SERVICE MANUAL, with Supplements,  
 1932 OFFICIAL RADIO SERVICE MANUAL, with Supplements,  
 and the 1933 OFFICIAL RADIO SERVICE MANUAL Complete  
 at a big saving.  
**THE SPECIAL NEW PRICE FOR ALL THREE MANUALS, WITH SUPPLEMENTS, IN ONE VOLUME, WITH HEAVY BINDER IS ONLY**

**\$14.00**

You buy this book this way—  
 Send \$3.00 with order—  
 Pay \$5.00 to Express Company upon receipt of book.  
 Send \$3.00 thirty days after receipt of book.  
 Send \$3.00 sixty days after receipt of book.  
 Total \$14.00.  
**IF THE ENTIRE AMOUNT IS SENT WITH YOUR ORDER, WE WILL ALLOW YOU A 10% DISCOUNT. THIS CAN BE DEDUCTED FROM YOUR REMITTANCE.**  
**IMMEDIATE SHIPMENT**

**OVER 2,300 Pages**  
**5,500 Illustrations**

**THIS IS THE GREATEST SINGLE VOLUME RADIO BOOK IN PRINT TODAY**

GERNSBACK PUBLICATIONS, Inc.  
 96-98 Park Place New York, N. Y.

**Mail Coupon Today!**

GERNSBACK PUBLICATIONS, Inc.,  
 96-98 Park Place, New York, N. Y.

Gentlemen:  
 In accordance with your Special Offer, I enclose herewith \$3.00 as first payment toward the One-Volume Radio Manual. Please forward it to me promptly. Upon receipt of the book, I shall pay express company \$5.00. Thirty days later I shall send you \$3.00, and sixty days after receipt of book, I shall send you my last payment of \$3.00. If you want to take advantage of the Special Discount of 10%, remit only \$12.60 with this coupon.

Name .....

Address .....

City ..... State ..... RC-11





"Takes the Resistance Out of Radio"

## THE RADIO SET OF 1950

An Editorial by HUGO GERNSBACK

I HAVE been asked a number of times during the past few months, by readers of RADIO-CRAFT, as to my ideas on the radio set of the future. I have, in the past, made many prophecies in connection with radio, a number of which have come true; and, since the radio set industry has been more or less in a state of chaos during the depression period, it is not surprising that radio people should want to know what the future radio set will be like.

While I do not claim to be endowed with supernatural powers, I believe that my guess as to the set of the future will not be very far out of the way in time to come. When I speak of the set of the future, I am not thinking of next year's set, or even the set of five years hence; but let us look at the radio set of, say, the vintage of 1950.

It is safe to say that the 1950 radio receiver will not be a midget set, nor a cigarbox type, nor a coat-pocket model. The chances are that it will stand at least four feet high, and possibly taller. It will not, however, look even remotely like the radio set of today; it will certainly not be a piece of furniture, nor will it be disguised as a bookcase or as a chest of drawers. It will be large, because the television angle will have been solved, and it will have either an open or concealed, ground-glass "faceplate," upon which the images appear. Most likely, there will be a sliding-panel arrangement to hide the ground-glass television panel when the set is not in use. The television panel will be presented at a convenient height for you, when you are sitting in a chair to watch the performance. Most likely the set will be swiveled; that is, the top, which contains the television apparatus, will turn in such a manner that (since the image is projected on a straight surface) it will not be necessary to move the entire set when you wish to view the image from a different part of the room. If you move to the right, near the window, you turn the top part of the cabinet so that the television panel is at right angles to your line of vision.

The tubes in this set will most likely be of the cold or filamentless type. They will be much smaller; probably not much larger than a thimble.

The chassis of this set will be radically different from anything we have today. *For quicker servicing, all parts will be demountable almost instantaneously.* Radio engineers will have come to recognize the fact that, no matter how well you build a set, certain components (such as transformers, condensers, coils, and the like) will not last forever, and must be replaced. At the present time, this means ripping the set apart. The set of 1950 will have most of the components mounted as we mount tubes today. There will be sockets, similar to the present radio tube sockets; or of the bayonet type, so that by a twist of the wrist you can pull out every transformer and every condenser to replace it. The same will be the case with the small fixed condensers, resistors, etc.

I can hear some of the present-day radio engineers throw up their hands in holy horror at this suggestion. They will say that you have such a multiplicity of unsoldered contacts that you will hear nothing but noise. They forget one important point, and that is that the radio tubes themselves, the heart of the radio set, are not soldered today; in a ten-tube set you will have as many as sixty "loose" contacts if the tubes have six prongs each. If the contacting arrangement is well engineered, we should have no fear of loose or microphonic contacts. Service Men will be able to replace parts in practically no time. It should also be remembered

that, by not having to worry with a filament supply, the set is simplified a great deal.

The tubes themselves will be vastly more efficient than those which we have today. By that time no doubt a real detector tube will have been evolved; one that is far more efficient than tubes in use today. The sensitivity of the tube itself will have increased several hundred per cent over what we have today. The result will be that the radio set of 1950 will require no ground, no aerial; that means less extraneous noise and static pick-up. Each set will have built right into the chassis a real filtering system—not the filter which we use today, but something radically different, which will effectively kill from 90 to 95% of the line noises that enter the set today by way of the power supply.

The loudspeaker of the future set will not bear the slightest resemblance to the one of today. It is almost certain that it will be of neither the magnetic nor the dynamic type; most likely, it will be a crystal type or a condenser type, or a combination of both. There is even a chance that the set of 1950 will have a multiplicity of loudspeakers, each to take care of a certain band of audio frequencies, in order to cover the complete range from the lowest to the highest tones.

By 1950, it is most probable that the present broadcast band will be abandoned, and that broadcasting will be done generally on wavelengths below 200 meters. If television is finally perfected, as it will be, the present broadcast wavelengths will be useless. Television broadcasting must be on wavelengths below 50 meters, and that is what the set of 1950 will be tuned to. Every station will broadcast television and sound, both on the same frequency. This I predicted in May, 1926, editorially, and it first came about in April, 1932, when the New York station of the Columbia Broadcasting System accomplished simultaneous sight and sound broadcasting.

There will be radio networks, like those of today; with the difference that almost every town will have its own local broadcasting unit to supply the radio sets of its locality.

On the television end, we will have, of course, no moving parts in the set of 1950. A somewhat overgrown radio tube will project the image on the ground-glass screen. (This screen will vary in size, but will never be smaller than about 9 x 12 ins. More elaborate sets will naturally require larger faceplates for larger projections.) There will be no flickering, no crossbands, on the television screen of the set of 1950. The image will be better and steadier than the picture which you see in your motion-picture house.

The set will of course have its output controls, whereby sound and sight can be regulated to your full satisfaction. Inasmuch as its television screen will be tremendously brilliant, you will never turn it on full (except in bright daylight) because the great output of light from the television tube would cause the image to hurt your eyes.

As the broadcasting stations will televise and transmit in full color everything that is going on, some of the more elaborate sets of 1950 will have color-television attachments to reproduce the image in full colors. The lower-priced sets will reproduce black and white; while the better sets will reproduce the three primary colors, red, blue, and yellow, giving all necessary colors in a full "halftone" effect.

The cabinet of the 1950 set will probably be all-metal. The entire set will be enclosed in metal, in order to keep out extraneous noises that otherwise would be picked up by the chassis. The set itself will positively not be open in the back to collect dust, as they are nowadays; it will be sanitary.

That the quotation, "There are more things in heaven and earth, Horatio, than are dreamt of in your philosophy," is a truism, becomes more obvious the more we learn. New developments in sensitive test devices have unearthed hitherto unknown psychic phenomena — a phase of radio technique which still is in the embryonic stage. The following article describes several interesting experiments.

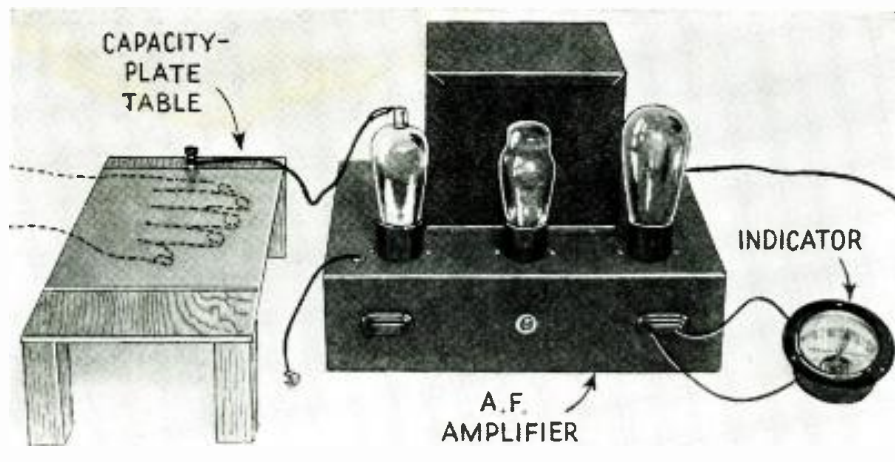

Fig. A  
Mechanical arrangement of the "open grid" indicating circuit.

## RADIO PSYCHOMETRY

CONSIDERABLE interest was recently created when Major Raymond Phillips, an English scientist, exhibited an instrument called a Radio Psychometer. This instrument is so sensitive that it is affected by anyone standing near, although a more pronounced effect is produced by placing one's hands near a copper plate connected to the device. Although no actual contact is made with the apparatus, the effect is such that model trains can be set running and the motion only ceases when the hand is removed from the vicinity of the copper plate. One experiment is illustrated in Fig. A.

### Hand Capacity?

There has been much speculation regarding the cause of the phenomenon. At first, it appears that it is a simple case of hand capacity, which changes the grid-to-filament capacity of the first tube of the A.F. amplifier—thus causing a change in the plate current.

However, Major Phillips points out the recent experiments of an eminent radiologist who, with novel apparatus of his own design confirmed the existence of an "electrical field" about the human body. He stated that many of the effects in radio communication attributed to "hand capacity" are probably due to this "electric field."

It is well known that the electrical resistance of the human body varies with motion. Delicate instruments have recorded the effect on a person of a sudden shock. It therefore seems reasonable that some of the "capacity" effects may be due to other phenomena.

Several simple experiments may be tried to show the presence of this field surrounding the human body. The first of these shown at A in Fig. 1, was tried in the offices of RADIO-CRAFT, but did not show any marked effects, perhaps due to the haste with which it was tried. It consists of a mahogany board 36 x 10 x 3/4-in. thick, carefully balanced on a knife edge. It is explained that when a person's hand is held over one end of the board, the latter (if it is carefully balanced) will, after a short time, oscillate slightly. *Some people, it is said, appear capable of producing stronger effects than others.*

The second experiment described is shown at B in Fig. 1. The apparatus consists of a phonograph motor, D, a tambourine, B, a lever with a needle point at one end, A, and a cylinder of glass covered with soot, C, suitably mounted on the phonograph motor so that the cylinder will revolve. The

needle point on the end of the lever is arranged to press lightly against the cylinder and the other end rests on the center of the parchment head of the tambourine.

It is pointed out that some people could not influence the needle point until the lever was very carefully adjusted, while others simply had to hold their hands near the tambourine head to cause the line on the smoked drum to move irregularly up and down as the latter revolved.

### The Psychometer

A diagram of the circuit used by Major Phillips is shown at A in Fig. 2. It will be noticed that the output of the amplifier is arranged to control a model electric train. The amplifier consists of a transformer coupled unit, the first tube of which has an open grid circuit, with a copper plate attached at A. Filament resistor R1 regulates the filament potential on tube V1, while the remainder of the tubes are controlled by an automatic filament ballast resistor, R2. A 400 ohm resistor is connected in series with the plate supply circuit to control the plate voltage. The "B" circuit is shunted by a condenser of 4 mf., labeled C in the diagram.

Relay No. 1 is wound to a resistance of 8,000 ohms and is connected across the output impedance T3, so that a change in the plate current will actuate it. Relay No. 2 is an ordinary low resistance unit with a winding of about 6 ohms. The main relay also has a resistance of 6 ohms and the armature is arranged to open or close the circuit to the model train.

When a person places his hand near the copper plate, A, the relays close, thus starting the train. When the hand is withdrawn, the plate current returns to its former value, and the relays open.

In the first part of this article, it was pointed out that the instruments developed by Major Phillips operated differently when different persons approached them. It has been found that the same thing applies to this instrument.

To check the experiments of Major Phillips, an amplifier unit was set up in RADIO-CRAFT laboratories. The circuit of this amplifier is shown at B in Fig. 2 and a photograph of the set-up is shown in Fig. A. Since Major Phillips explained that different persons affected the device differently, we arranged the unit with a sensitive current meter in the plate circuit of the output tube. This meter measures the difference in plate current when different persons place their hands near the plate.

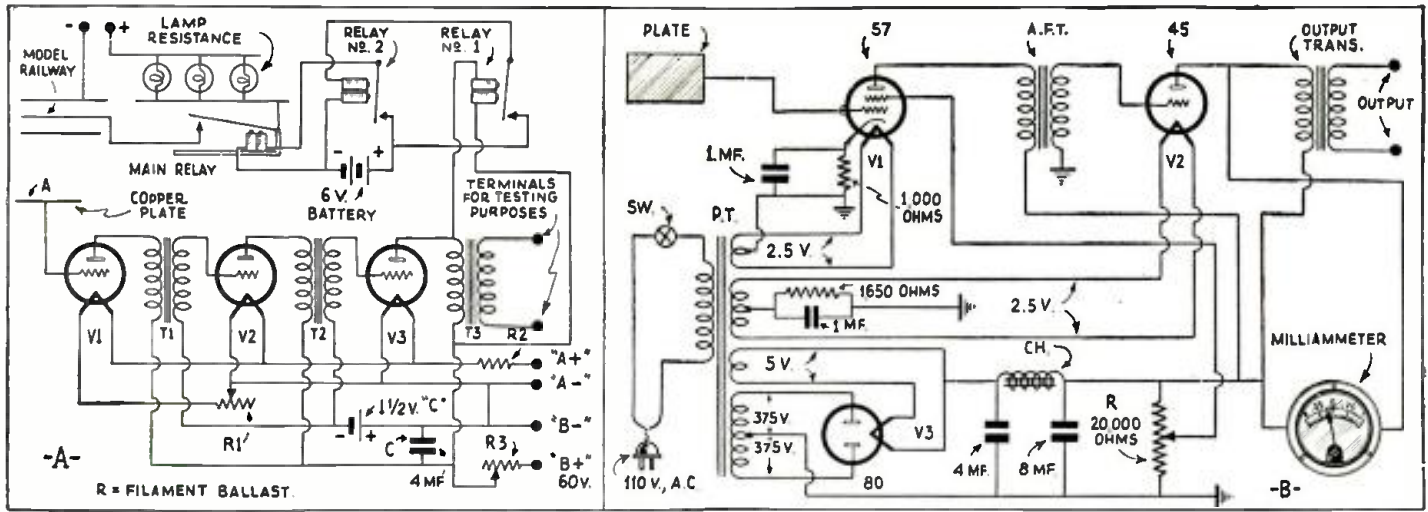

Fig. 2

At A, schematic circuit of Major Phillips' radio psychometer; the circuit at B shows electrical connections followed in the set-up shown in Fig. B.

## THE 1934 ULTRA-MODERN SUPER.

In reading the above title, readers of RADIO-CRAFT will immediately recall the article, "Building and Operating An Ultra-Modern Super.," which appeared in the October, 1932 issue of RADIO-CRAFT. To these technicians, particularly, we call attention to a construction article on the modernized version of this instrument which is to appear in a forthcoming issue of RADIO-CRAFT; owners of broadcast receivers built in accordance with the older design will find it particularly convenient to convert their chassis to the newer construction, since they will have most of the equipment on hand.

The new type 2A7 tube is used as the combination oscillator and first-detector. The new 2A6 is used as a second-detector and in order to obtain improved A.V.C. operation. Meter tuning is now incorporated in the design. Also, interstation noise suppression is included in the form of a silent-tuning switch.

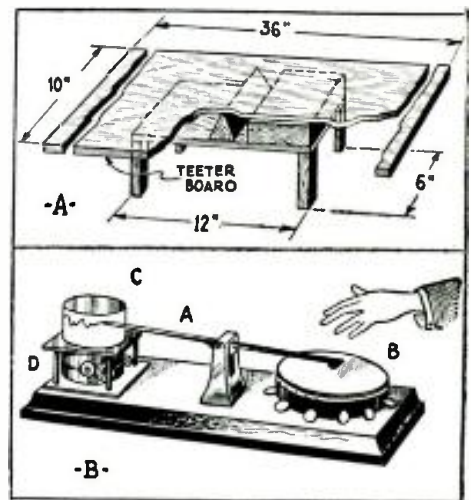

Fig. 1

Two of Major Phillips' psychometer units.

The circuit of the amplifier unit used in our tests is a straight transformer coupled arrangement, using a screen-grid tube for the input tube, and feeding through an audio transformer with a high-impedance primary to a triode output tube.

The unit has a self-contained power unit of conventional design, using a type 80 rectifier tube. The usual power transformer and filter arrangement used in practically every A.C. power unit, are employed. The values of all the parts are shown in the diagram, Fig. 2B.

As a means of controlling the sensitivity of the unit, a potentiometer, R, is employed as a combined bleeder resistor and voltage control for the screen grid of the 57 tube. A point will be found on this potentiometer scale that effects a compromise between stability (to prevent the unit from starting parasitic audio oscillations) and sensitivity (to remain sufficient to show an appreciable change in plate current when the "capacity plate" is approached).

The current meter, which may be either a sensitive milliammeter or a galvanometer is connected across the primary winding of the output transformer.

No connections are shown for the secondary of this transformer, but if desired, a loudspeaker may be connected to it, to give an audible indication of whether the amplifier is oscillating or not. This will permit the operator to adjust R to the point of greatest sensitivity of V1.

It may be necessary to connect a "C" battery and resistor across the connections to the current meter, to prevent the normal plate current from throwing the indicating pointer

completely across the scale. This battery, which may be an ordinary  $4\frac{1}{2}$  V. battery, is connected to "buck" the normal flow of plate current through the meter. The positive terminal is connected to the plate of the 45 tube, while the negative end is connected through a 0.5-meg. variable resistor to the other terminal of the meter. The 0.5-meg. resistor is then adjusted to the point where the indicating pointer is at zero, when the amplifier is in operation. A switch should be provided, to break the connections of the bucking battery to the meter, so that current will only flow when the unit is being used.

In trying the device out, an arrangement was used (not shown in the photo) so that the proximity of the hand to the plate was always the same, to prevent this from affecting the results obtained. Varying current readings were noted for different subjects.

We will not attempt to detail the results of our experiments. However, we might point out that as different persons affect the unit differently, a field of experimentation is opened up for those interested. It is quite possible that the system could be used as suggested on our cover, to classify people according to their nervous temperament, or according to their mental activity, etc.

We will be interested in learning of the results obtained by experimenters who try any variation of the Radio Psychometer.

(Credit is hereby given to AMATEUR WIRELESS, a recent issue of which English publication contained an article mentioning many of these experiments; the explanations are quoted.)

# LATEST RADIO EQUIPMENT

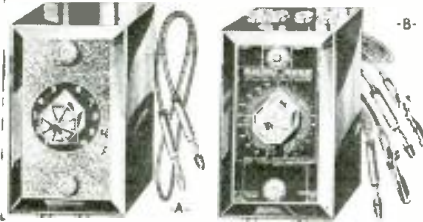

Two new radio instruments (No. 147)

## NEW RESISTANCE-TEST UNITS

TWO handy servicing units are shown above. The first, A, is a decade resistance box supplying ten resistance values from 0.1-meg. to 1. meg.

The second, B, contains a calibrated, 0-0.1-meg. resistor unit consisting of a special 25,000 ohm potentiometer and three 52,000 ohm carbon resistors.

These handy servicing items which are each mounted in small bakelite boxes are useful for substitution in circuits under test and for measuring resistance values by the substitution method.

## VOLT-OHMMETER

A NEW instrument, shown below, has been designed to meet the need for point-to-point service instruments. An outstanding feature of the new unit is its automatic vacuum relay which prevents costly burn-outs of meters or circuits—the relay automatically throws the circuit open, then closes it when the overload is removed.

The instrument weighs only 2½ lbs.; it is 7 x 4 x 3 ins. deep. The voltage ranges are 3; 30; 300 and 600. The resistance ranges are 0 to 1000; 0 to 0.1-meg. and 0 to 1. megohm. The basic meter reads 0 to 1 ma.



Volt-ohmmeter unit No. 148

Name of manufacturer of any device will be sent on receipt of a self-addressed, stamped envelope. Kindly give (number) in description under picture.

## A DUAL-USE "FILTER"

THIS handy unit for the Service Man's kit is shown below. It is a combined line filter (for reducing noises introduced through the power supply), and aerial coupling unit.

For the first-mentioned application the unit may be plugged into the line, either at the receiver or at the offending electrical device.

The aerial coupling unit may be used to increase the selectivity of sets by adjusting the knob (between the two binding posts); or for replacing the outside aerial by connecting the aerial terminal on the set through the unit to ground.



Noise filter and aerial connector (No. 149)

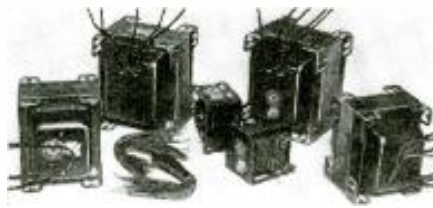

Replacement transformer kit (No. 150)

## A KIT OF TRANSFORMERS

TO meet the urgent demand of Service Men for immediate service on the replacement of transformers without maintaining a large stock, a kit of multi-tap transformers, shown above, has been introduced. Slotted frames permit easy mounting. The designs "fit" over 90% of the sets.

These replacement transformers may be installed as permanent equipment.

Four power transformers are included in the kit, one for 4-tube sets, one for 5- or 6-tube, one for 7- or 8-tube, and one for 9- or 10-tube.

The fifth unit in the kit of six transformers is an A.F. output transformer with various tap combinations to couple from single or push-pull stages to any voice coil from 2 to 30 ohms.

The sixth unit is a universal A.F. input transformer which can be used in push-pull or straight A.F. circuits.



Dual-scale resistance indicator for determining replacement resistor values (No. 151)

## RESISTANCE INDICATOR

THIS dual-scale indicator, illustrated above, is used in determining resistor replacement values. Two clips are connected across the burned-out resistor, and the radio set turned on. The special, rounded contact is then gently run along the high-resistance scale, starting from the 0.1-meg. end. When the set functions correctly, the desired value of the replacement resistor is read from the scale; for values below 1,000 ohms the low-resistance scale is used to obtain greater accuracy.

## CRACKLE-FINISH RADIO PAINT

THE radio constructor and the Service Man who prides himself on doing an unusually good job will find these paints indispensable. (Part of a dealers' display "board" is shown below.)

The paint is applied in the usual manner, by brushing lightly over the surface, and after about 20 minutes the surface crinkles and forms itself into beautiful designs which enhance the appearance of any object.

Both transparent and opaque paints are available for surfaces in amber, blue, red, green, white, black and gold.



Radio Paint for "crackle" finish (No. 152)

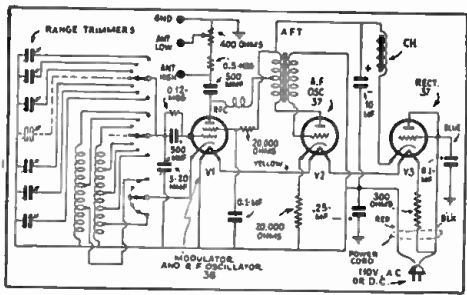

Above  
The circuit of the I.F., R.F. oscillator.  
Right

The rear view showing the trimming condensers.

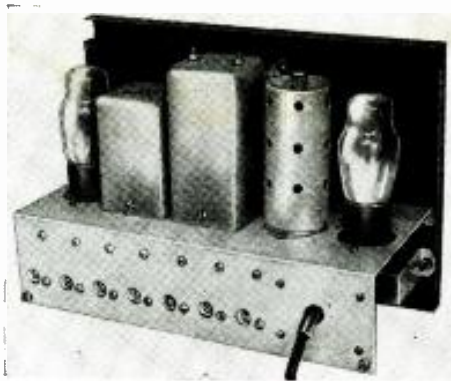

Above  
The latest in test oscillators (No. 153)

## A NEW TEST OSCILLATOR

**A** TEST oscillator for the radio Service Man, having the frequency stability of a laboratory-type signal generator, has just been announced. It is illustrated, above, by picture and diagram.

The usual self-modulated oscillator circuit is not used. The unit employs three tubes; (1) the R.F. oscillator stage; (2) a separate modulator stage; and, (3) a rectifier tube, for this instrument operates from any light socket, A.C. or D.C., eliminating battery cost and weight.

The "electron-coupled" oscillator circuit gives freedom from frequency variation due to voltage changes or input circuit conditions. Complete coverage of all intermediate broadcast- and short-wave bands is provided, including the new 546 and 477.5 kc. intermediate frequencies used in the latest sets of foremost manufacturers.

The whole unit is contained in a single steel housing, with a black crackle finish. Output frequencies are adjusted at the factory to zero-beat against a crystal oscillator; the

controls are sealed while the zero-beat is maintained.

The power cord contains a resistance element and will heat somewhat in normal operation.

It is not essential to ground the case to secure satisfactory operation, but the connection serves as a static drain on the line filter condensers within the instrument.

A shielded cord is supplied for connection of the oscillator to the receiver under test; the sheath of the cord (the black unshielded tab) connects to the ground connection of the oscillator and the ground post of the receiver. The tip from the inner shielded wire should be inserted in the jack marked HIGH or LOW, in accordance with the nature of the test being made. Note that the attenuator control marked R.F. OUTPUT is effective only with the tip in the LOW jack. When placed in the HIGH jack, a potential of about 0.5-V. and of fixed value is imposed on the cord. Also, it is then possible to make A.F. tests directly by connecting the other end of the shield wire into the grid of one of the A.F. tubes.

(Continued on page 295)



A 13 W. P.A. amplifier (No. 154)

## A 13 WATT P.A. AMPLIFIER

**T**HE use of a class B audio circuit together with carefully designed components have provided the P.A. amplifier shown above with many desirable features—especially for a portable or mobile sound system—such as light weight, compactness, high output with fairly small tubes operating at low plate voltages, and economy of power consumption.

An exclusive feature in the design of this amplifier provides for a rapid change-over from 6 V. storage battery operation to 110 V., A.C., or vice-versa, without changing any tubes—or using adapters. It is only necessary to insert the 5-prong plug into either one of two sockets mounted on the right-hand end of the chassis. The front socket is used for 110 V., A.C. operation, while the rear socket is used when the amplifier is operating from a storage battery.

When the amplifier is being powered from a storage battery, it utilizes a vibrator-type converter-rectifier which

operates from 6 V., D.C., and furnishes the high voltage (250 V. at 75 ma.) required by the amplifier.

This device draws only 4.7 A. from the 6 V. storage battery and requires no thermionic tube for rectification; mechanical rectification is obtained by means of an extra set of contacts on the vibrator assembly. The complete mechanism is mounted upon an air-cushioned rubber base and provided with two electrostatic, electromagnetic and sound-proofing shields. The device is not only quiet and fool-proof, but operates with approximately 30% more efficiency than can be obtained from most rotating machines.

When the system is operating from 110 V., A.C., the type 83 rectifier employed produces not only sufficient current for the amplifier requirements, but also furnishes field current for as many as six, 2,500 ohm dynamic speaker fields.

By employing dual-field dynamic speakers (containing both a high voltage—2,500 ohm—and a 6 V. field winding) it is possible to excite the speakers from either a 6 V. storage battery or from the amplifier (when it is operating from 110 V., A.C.).

The first A.F. stage uses a type 78 tube; the second, driver, an 89; and the third, class B output, two 79's.

A combination 6 V., D.C. and 110 V., A.C. operated phono. motor and turntable are also available to complete the universally-operated accessories for this amplifier system.

## NEW TUBES

**T**HE type 1A6 tube, shown below, is a "pentagrid converter" designed primarily for use as a combined oscillator and mixer in battery-operated superheterodyne receivers. The 1A6 possesses many operating advantages over the oscillator-mixer combinations hitherto employed. Among these advantages are: economy in "A" current drain, greater operating stability, high I.F. gain, higher and more uniform translation gain, volume control effectiveness comparable with that of a variable- $\mu$  amplifier in an I.F. stage, reduction or elimination of the intercoupling effect between the signal and the oscillator circuit, almost entire elimination of radiation from the local oscillator, simplicity of oscillator circuit adjustment, and economy in

(Continued on page 296)



The 1A6 tube (No. 155)

# INTERNATIONAL RADIO REVIEW

## A "Self-Tuning" Circuit

A RECENT issue of POPULAR WIRELESS, London, England, contained an interesting discussion of a new method of tuning, in which the radio frequency circuits automatically tune themselves to any applied frequency! The action depends on what is called the "Miller effect."

As everybody knows, there is a definite electrostatic capacity across the electrodes of a tube which in the days before screen-grid tubes gave a lot of trouble by causing self-oscillation. Some years ago a physicist named Miller discovered that this capacity effect is not the same when the vacuum tube is lit as when it is cold. Not only does the apparent capacity between electrodes change, but its value depends upon the kind of circuit used in the output of the tube. In short, the effective grid-to-filament capacity varies with the effective impedance of the output circuit.

Now, since the effective inductance in the plate circuit of a tube automatically increases with the frequency of the signal it is handling, it follows that the Miller effect on the grid-to-filament inter-electrode capacity also will change. One can, therefore, imagine an inductive output circuit so designed as to increase the grid-to-filament capacity inside a tube on long wavelengths and to decrease it on short wavelengths.

This occurs in the circuit shown at A in Fig. 1. The input circuit to the screen-grid amplifier is untuned, but the coil L1 is shunted by a tube, V1, the plate of which is connected to the "B" supply through an inductive load, Z. Now,

HERE is what the radio experimenter has been wanting for a long time — a semi-technical review of the thousands of new ideas which are continually appearing in overseas publications. Each month there are received at the offices of RADIO-CRAFT hundreds of daily, weekly and monthly magazines originating from every point on the face of the globe.

SINCE the cost of subscribing to each of these would be prohibitive for most radio men, we have arranged with technical translators to prepare for our readers reviews of all the really important, new developments illustrated and described each month in these international radio periodicals.

NOTE that the only available information is that which is published; the experimenter must adapt the ideas to whatever equipment he has on hand.

if the frequency of the signal fed to the coil L1 is altered, the effective inductance of Z in the plate circuit of that tube will also change, and in turn will vary the grid-to-filament capacity.

Of course, without some further control, the tuning would tend to adapt itself to several stations at once. To prevent this it is necessary to use a single pre-selector or band-pass circuit coupled to coil L2 as shown at B, Fig. 1. This eliminates the need for multi-ganged controls.

## A Novel P.A. Amplifier

A RECENT issue of WIRELESS WEEKLY, an Australian radio magazine, contains a rather interesting form of push-pull amplifier for P.A. work. The 180-degree out-of-phase potential for push-pull operation is obtained from the cathode or grid-return circuit.

It consists of a 3-stage amplifier, shown in Fig. 2. A diode-triode tube, V1, is used, so that the amplifier can be adapted for radio work by the addition of a simple tuning unit. By using the diode type of detector, it becomes feasible to retain the fidelity possible with the amplifier, when working on

radio. But for the amplification of pick-up from phonograph records, the audio section (triode portion of the diode-triode) of V1 is used, being resistance coupled into a pair of 56 type tubes in push-pull.

(This change from single tube to push-pull without the use of an input transformer is the most interesting part of (Continued on page 299)

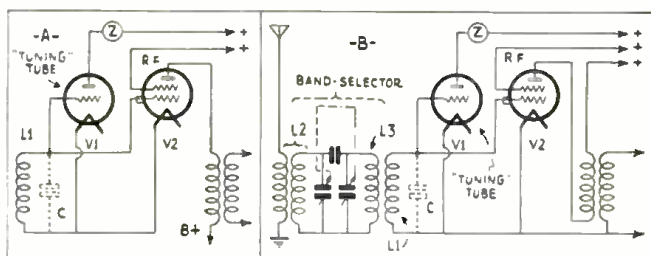

Fig. 1

Inter-electrode capacity, C, variation in V1, tunes L1.

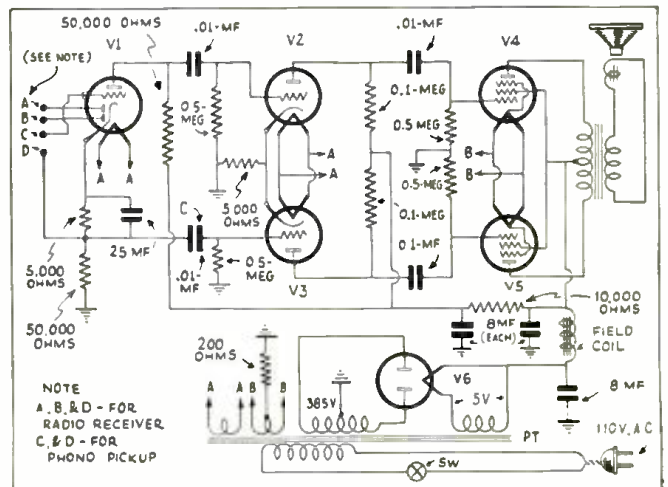
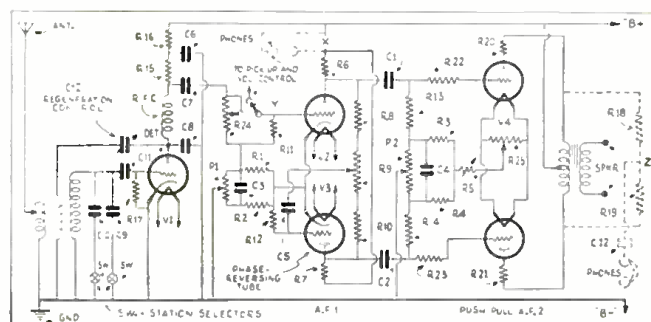

Fig. 2, Above

This novel push-pull amplifier requires no transformer to obtain the counter-phase potential, which is derived from the grid-return circuit of V1.

Fig. 3, Left

The "perfect quality" receiver—brought up to date. Stage A.F.1 secures push-pull output performance without the use of a transformer.

# THE NEW "RESONATOR" LOUDSPEAKER

The author describes the use of a system of tubes, resonant at one or more points in the audio scale, for reenforcing the output of a dynamic reproducer.

ALL loud speakers incorporate a motor unit which transforms the electrical vibrations in an A.F. circuit into mechanical vibrations of a diaphragm moving in air. But although the electric input to the motor unit may be "perfect" within practical limits, so many factors are introduced in the subsequent steps that seldom do we find the tone quality of our air vibrations to be mechanical replicas of the electrical waveform.

Let us consider the instance of an electro-dynamic reproducer with a free cone, one of the best types of reproducing devices in general use. To correctly utilize the "dynamic," we must use a "baffle," as large in proportion as the lowest frequency to be reproduced, to separate the fore part of the cone from the back. Although this construction successfully prevents the compression wave produced by the front, concave part of the cone from being cancelled by the expansion wave being produced simultaneously by the convex part, we are utilizing only a part of the available energy—only that which is produced from the front of the cone. Another disadvantage is the directional characteristic which results when a baffle is used. Further, it is generally recognized that a dynamic reproducer having a small cone is not as efficient in reproducing the low notes as one having a larger

\*Paris, France, correspondent.

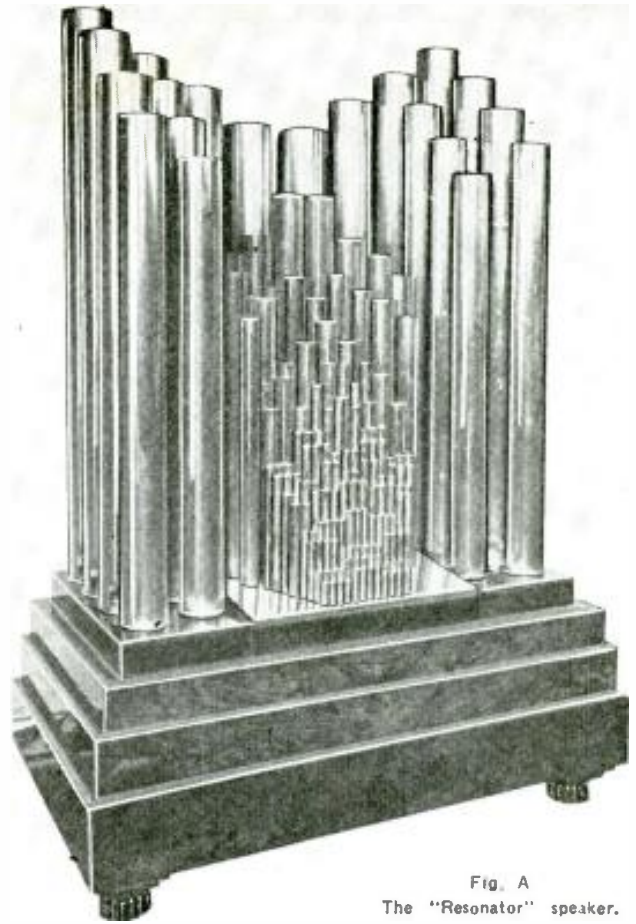

Fig. A  
The "Resonator" speaker.

## PIERRE HEMARDINQUER\*

cone; and vice versa. These sources of faulty reproduction explain in part the need for tone "compensation" and "correction" in modern sets and reproducers.

The simplest of all resonators is made of air held in a hollow box. Then there is the classical experiment, illustrated in Fig. 1, of holding a vibrating diapason (standard  
(Continued on page 299)

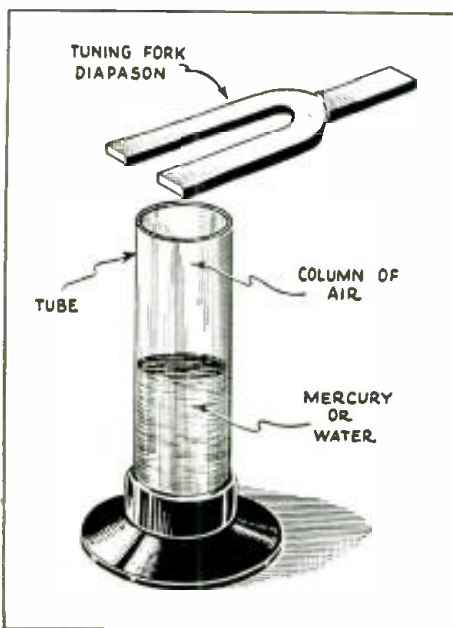

Fig. 1  
Demonstrating resonance effects.

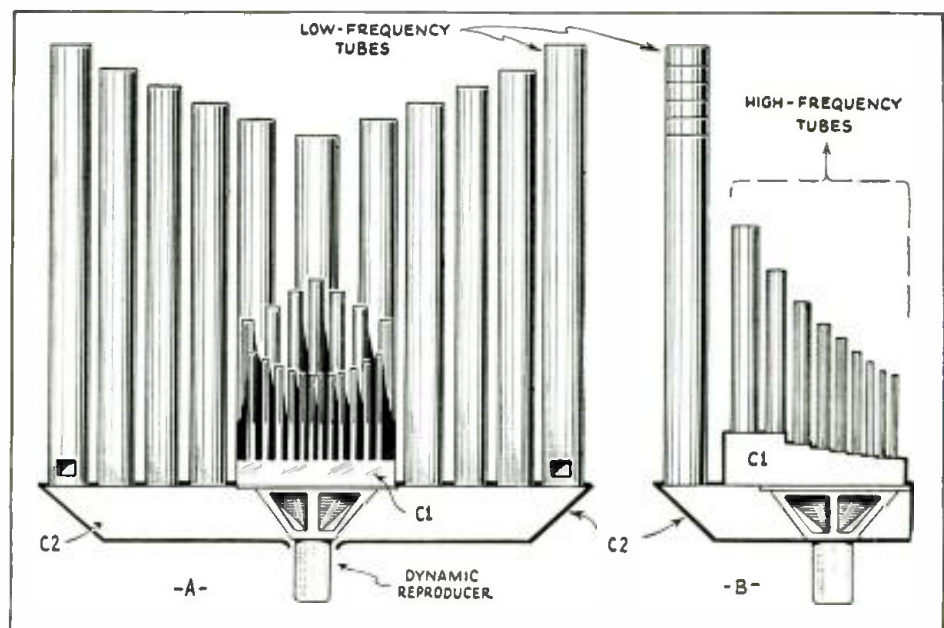

Fig. 2  
At A and B, front and side views, respectively, of the new speaker.



Fig. A  
Domesticating the radio robot.

# A RADIO ROBOT —IN THE HOME

ARNOLD  
G.  
FERDON\*

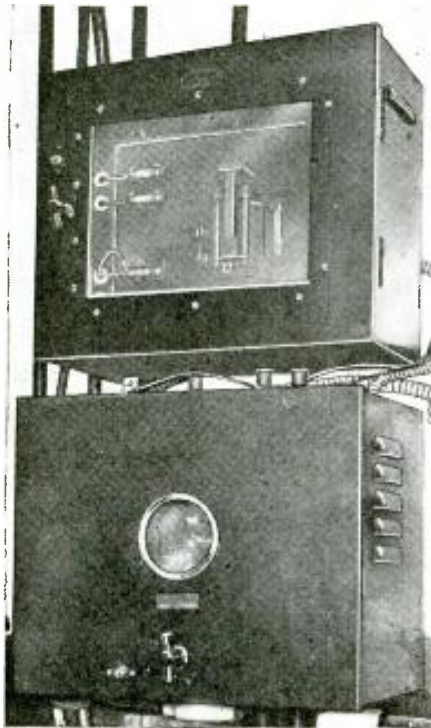

Fig. B  
Master Clock relays and timers.

A RADIO "Utopia" is probably the best expression to use in describing the radio system installed for Mr. A. J. Powers, president of a New York firm, who has his offices and apartment in the same office building in the heart of the metropolitan district. On the roof of the building, he has one of the most complete indoor and outdoor gymnasiums in the city and a roof garden that is certainly a pleasant surprise to anyone viewing it for the first time.

Mr. Powers' offices and home have every possible modern convenience to make life and work more enjoyable. He spares no cost in keeping up to date; as he says, "I believe in being not only up to date but ahead of the times."

A very good example of the above attitude is shown in the radio installation. This system is an elaboration of the telektor system which was described in the May, 1932 issue of RADIO-CRAFT. Primarily, it consists of a combination radio and phonograph, equipped with three speakers located at various points,

with a remote control unit at each speaker. Mr. Powers is shown in Fig. A, operating one of the remote controls.

However, remote operation is not the only feature of the system. Two Landis program machines are used in conjunction with a Stromberg-Carlson Master Electric Clock to turn the receiver on and off automatically at any pre-determined time. (The electrical units with their various relays and timing devices for the Stromberg-Carlson Master Clock are shown in Fig. B.) Programs can be selected *a week in advance*, and the radio may be turned on for any length of time! The program machines are equipped to make and break 16 separate circuits at one minute intervals over a period of 168 hours, or one week. At the beginning of each week, Mr. Powers indicates on a radio schedule the programs he wants to hear. A secretary then adjusts the program machine so that the receiver is automatically turned on before the program begins.

However, Mr. Powers is not satisfied with having the radio turned on and off in this manner. He desires to be reminded before the program starts, so

\*Home Radio Service, Inc.

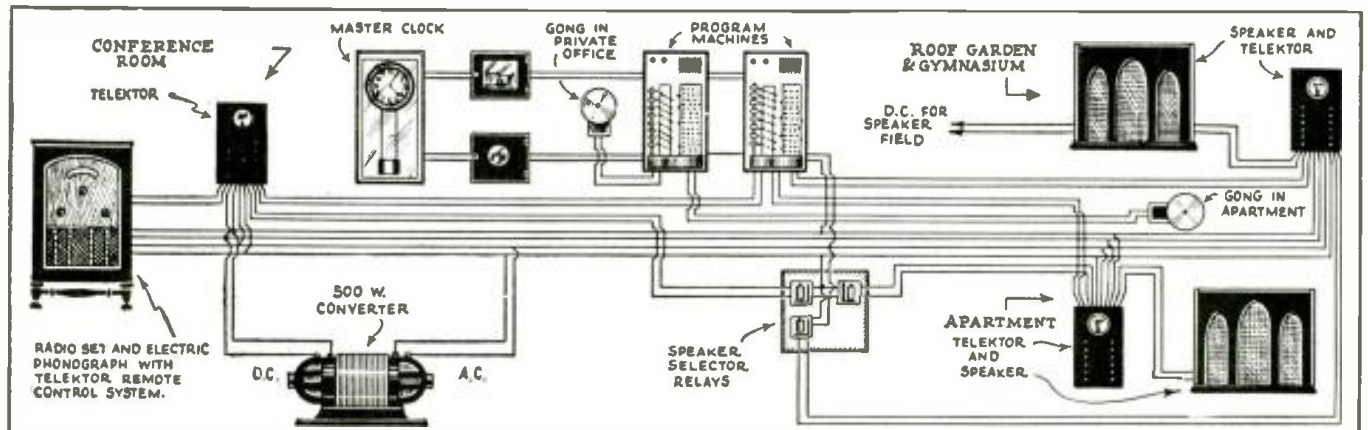

Fig. 1  
A block illustration of the equipment and its hook-up in the domestic version of the radio robot.



Few radio technicians are aware of the strides which have been made in the practical application of radio principles. Consequently, we take pleasure in presenting the details of an ultra-modern radio installation in the home. Progressive radio Service Men will show this article to neighborhood prospects.

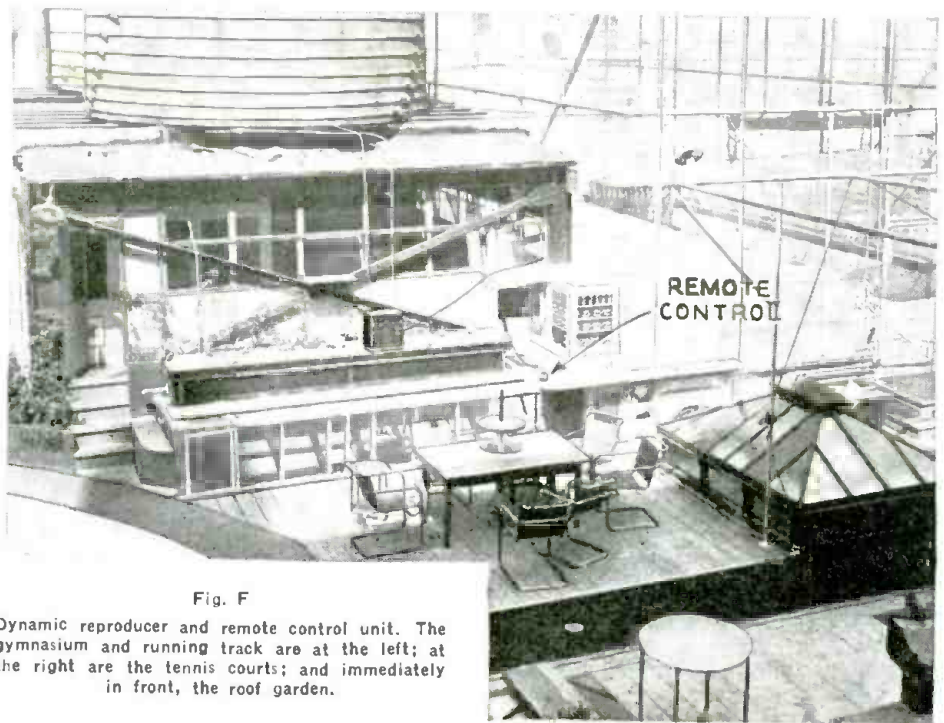

Fig. F  
Dynamic reproducer and remote control unit. The gymnasium and running track are at the left; at the right are the tennis courts; and immediately in front, the roof garden.

that he can walk leisurely into his "conference room" and sit in comfort while the program progresses. To accomplish this, the program machine is again called into service; a gong is installed in his private office and his apartment. These gongs chime one minute before a program starts.

The program machines which are the "heart" of the system are very interesting units. One of these devices is shown in Fig. C. It consists of three selector cylinders, the largest one of which shifts each minute when the electrical impulse from the Master Clock is received; a smaller one which shifts once each hour; and a third which shifts once every day. As you will notice in

Fig. C, the large cylinder is perforated over its entire surface. These perforations are for a specific purpose—when pins are inserted in the holes, a contact is made at a given minute, hour, and day, so that the various circuits involved may be completed.

One program machine turns the radio off and selects the station, while the second turns the outfit on, selects the speaker or speakers to be used, and sounds the chime which announces the program. Pins inserted in the large cylinder control all of these operations, for any period of time from one minute to 168 hours.

(Continued on page 298)

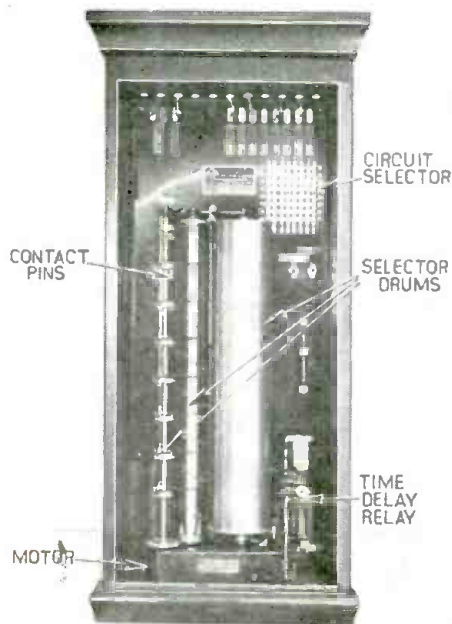

Fig. C, above  
Week-adjusted program machine.  
Fig. D, right

A bank of speaker-selector relays. It is these units that determine which speakers operate.

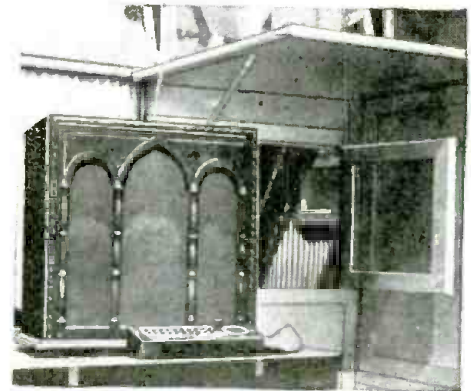
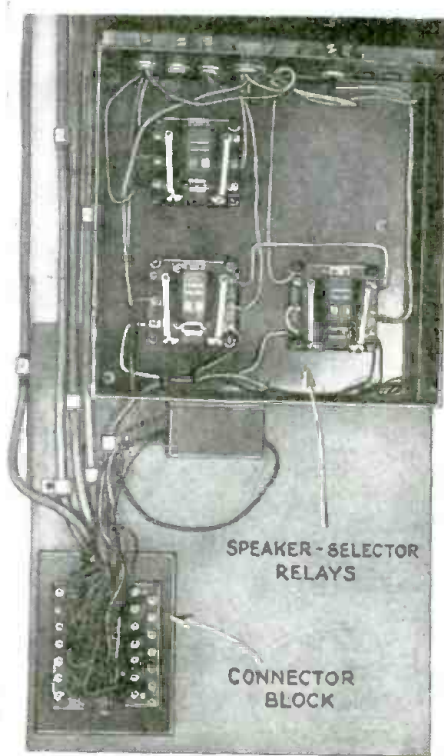

Fig. H  
A close-up of the speaker shown in Fig. F.

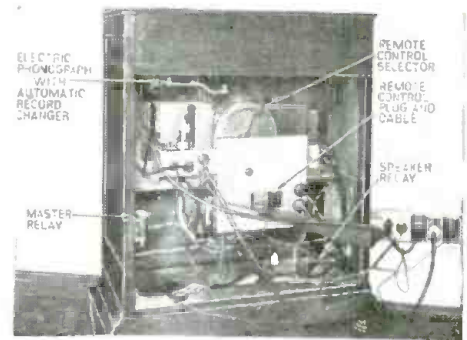

Fig. E  
The remote control radio set.



Fig. G  
A two-room speaker installation. When the doors on either side are closed nothing can be heard.

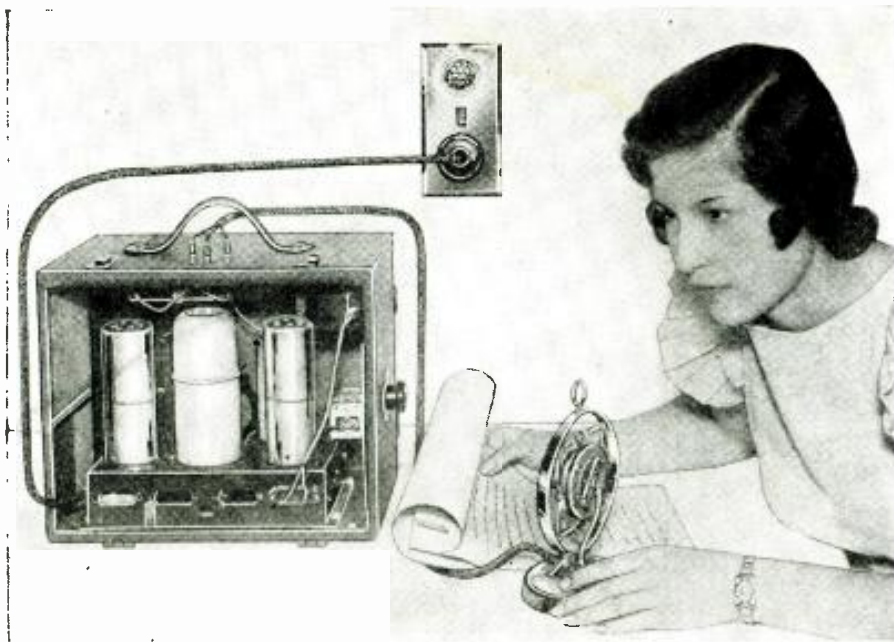

Fig. A

The new wired-radio public address amplifier in service, "broadcasting" over a hotel's light-power lines.

ANNOUNCING —  
 An entirely new system of P.A. operation. An audio frequency modulated radio amplifier is used to "power" the entire electric light wiring system of a room, a home, or even an entire hotel. To receive the "broadcast" it is only necessary to plug an ordinary radio receiver or suitable detector-and-amplifier unit into any electric light connection in the room or building, as the case may be.

# A WIRED-RADIO PUBLIC ADDRESS SYSTEM

DAVID R. FREELING

**T**HE novel and highly efficient device illustrated in Figs. A and B has for its purpose the elimination of all the usual wiring, either temporary or permanent, between the microphone and public address amplifier with no limitations in the distance between the two. The advantages of not having to *wire for sound* will be at once apparent to any engineer or Service Man who has occasion to lay out yard after yard of multi-conductor cable through corridors, rooms, stairways, airshafts—and at the same time prevent unwary feet from tripping over it. Anyone who has experienced these and some of the added difficulties of hurried connections, will appreciate the advantages of this newest development in sound engineering.

This versatile device is based upon the application of certain well known principles in the radio art. It takes the place of the usual preliminary amplifier and differs in function from it only insofar as it is designed to operate over the electric light lines, by generating and superimposing a carrier-wave upon the wires.

## Circuit

The circuit, Fig. 1, used for this pur-

pose is fundamentally that of a Hartley oscillator with Heising modulation using a type 45 tube as an oscillator and a type 27 as a modulator. Adaptation to the electric lighting system is accomplished by capacity coupling; several novel features are incorporated. Both sides of the A.C. line are used and a ground potential is established through the BX conduit and piping in the building. Radiation from the instrument is prevented by enclosing the entire apparatus in a metal cabinet and grounding it. The power pack, Fig. 2B, is of conventional design with the exception of two large R.F. chokes in the input of the power supply to prevent R.F. feed-back and two 0.1-mf. condensers to act as a bypass to ground. An efficient matching transformer and a two-button microphone with button current furnished by a small "C" battery completes the ensemble.

## Operation

Operation is very simple. You simply plug the "unit" into any convenient 110 V., A.C. socket or receptacle, press a button and talk. The modulated carrier-wave is instantly impressed on the lighting system and the voice modulations carried over the wires to a remote

radio receiver or suitable amplifier.

The amplifier ordinarily used with the system is especially designed for "line operation." For this purpose it has a special coupling device built in ahead of the first stage. See Fig. 2A. This device consists essentially of a fixed inductance with a variable condenser, C17, connected across it. A type 27 tube, V4, serves as a detector and rectifier of the high-frequency carrier-wave; three 0.1-mf. high-voltage condensers are used for coupling this unit to the line.

While designed primarily for professional sound applications, the wired-radio P.A. system has a multitude of other uses. For instance, due to the small amount of power used and because its radiations are confined to the electric light wires by the natural shielding effect of the iron conduit through which all light wires are run, the wired-radio P.A. system may be used in the home without fear of outside radiation.

To use your radio set as a powerful public-address amplifier, simply disconnect the aerial at the set, replace it with the ground wire, and *your radio receiver is then ready to pick up speech or music as "broadcast" from any place in the house where you may have plugged in*

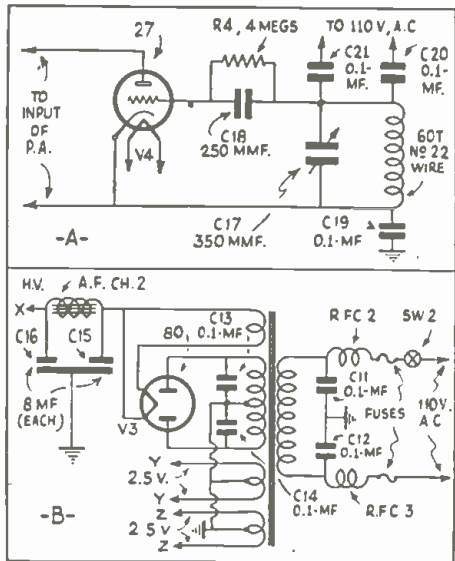
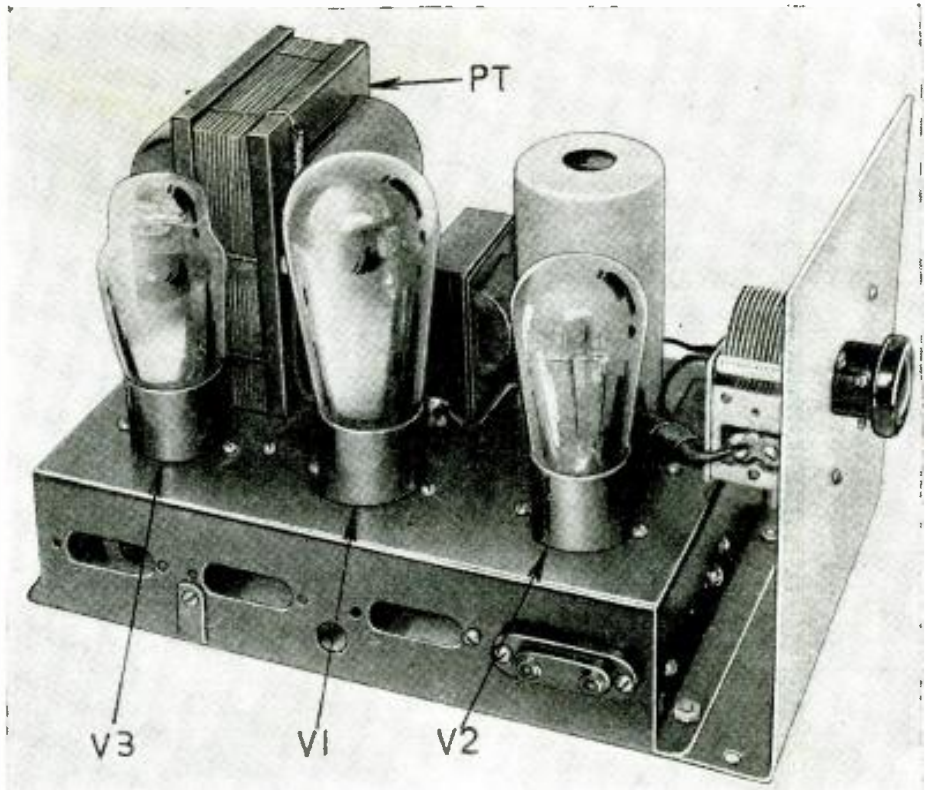

Fig. 2. Above  
At A, above, is shown an input detector unit suitable for use with any type of power amplifier at the "receiving" end of the R.F. P.A. system. At B is shown the power pack required for the wired-radio P.A. unit, illustrated by diagram in Fig. 1. In Fig. 2A, coil L2 is the 60 T. unit.

Fig. B, Right  
An interior view of the wired-radio P.A. unit. The small components are underneath the chassis.



the P.A. unit. Leave the radio set connected as described and conceal the R.F. P.A. unit in a room and you can create endless amusement at parties by arranging to listen-in on any conversation that takes place at the remote point. Replace the microphone (attached to the system) with any electrical phono. pickup and you can broadcast your favorite records over the home electric lighting system to your radio receiver.

These are but a few of the many applications of this new and useful device.

#### Constructional Data

In building the R.F. P.A. transmitter and amplifier coupling device, it is not necessary to do any special coil winding or machining of small parts. *Standard parts may be used throughout.* For this reason, no detailed description of the construction has been attempted.

Coil L1 is tapped at the 30th turn; L1 and L2 are tight-wound (except L1 antenna, whose turns are spaced  $\frac{1}{8}$ -in.); No. 22 D.C.C. wire is used for all coils; the winding form is a tube 2 ins. in diameter. For R.F.C.2 and R.F.C.3, random-wind 500 T. of No. 22 D.C.C. wire on a tube 2 x 1 in. in diameter. Ordinary 30 hy. filter chokes are suitable as Ch.1 and Ch.2.

The amplifier illustrated and described was a "hand" model. A "commercial" model, now available, is called the "socket mike" and looks just like a condenser mike and head-amplifier; the principle of operation however is the same as indicated in Fig. 1.

The simplicity of the Hartley oscillator circuit and Heising modulation system is such that the pictures, diagrams, and lists of parts, should be all that are necessary to enable anyone to build and operate the system. The writer will be very glad to answer any "legitimate" inquiries concerning this device, which fills a long-felt need in several fields.

## LIST OF PARTS

### Modulated Oscillator

- One center-tapped inductance coil approximately 60 turns of No. 22 D.C.C. wire (antenna coupling, 10 turns), L1;
- One 350 mmf. variable condenser, C1;
- One 2 meg. grid leak, R1;
- One 250 mmf. condenser, C2;
- Three 0.1-mf. condensers, C3, C4, C5;
- Two .006-mf. condensers, C6, C7;
- One .01-mf. condenser, C8;
- One 5 mf. condenser, C9;
- One .25-mf. condenser, C10;
- One 30,000 ohm resistor, R2;
- One 2,000 ohm resistor, R3;
- One R.F. choke, 85 mhy., R.F.C. 1;
- One 4-prong socket, for V1;
- One 5-prong socket, for V2;
- One type 45 tube, V1;
- One type 27 tube, V2;
- One microphone transformer, T1;
- One microphone, MIC;
- One cord, plug and socket for microphone;
- One "C" battery;
- One "C" battery switch, Sw. 1;
- One chassis;
- One 6 ft., two-conductor cable and plug;
- One A.F. choke, A.F. Ch. 1.

### Power Pack

- One power transformer, with two 2.5 V. filament windings, a 5 V. winding, a 750 V. winding with center-tap, and equipped with an electro-static shield, PT;
  - Four 0.1-mf. condensers, C11, C12, C13, C14;
  - Two 8 mf. electrolytic condensers, C15, C16;
  - One A.F. choke, Ch. 2;
  - One 4-prong socket for V3;
  - One type 80 tube, V3;
  - Two 30 A. fuses;
  - One fuse block;
  - One power switch, Sw. 2;
  - Two bank-wound coils, No. 22 D.C.C. wire, used as R.F. chokes in A.C. line, R.F.C. 2, R.F.C. 3.
- ### Pickup Unit
- One coil of approximately 60 turns of No. 22 D.C.C. wire, L2;
  - One variable condenser, 350 mmf., C17;
  - One fixed condenser, 250 mmf., C18;
  - Three 0.1-mf. condensers, C19, C20, C21;
  - One 5-prong socket, for V4;
  - One type 27 tube, V4;
  - One 4 meg. grid leak, R4.

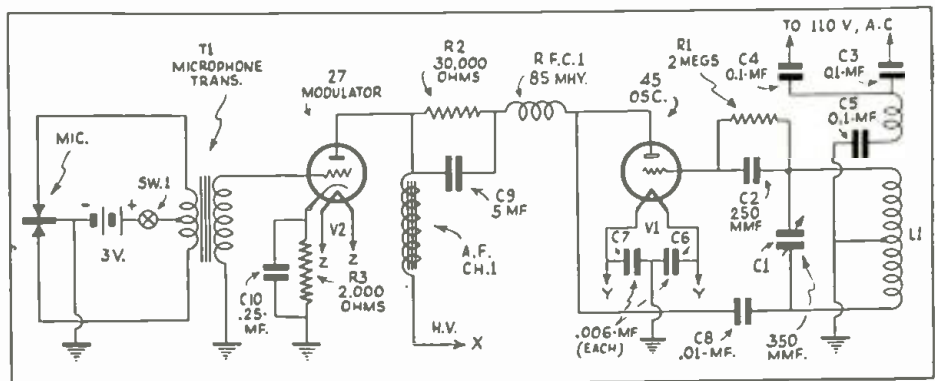

Fig. 1  
Schematic circuit of the new wired-radio public address system.

Intimate in Character  
International in Scope  
Independent in Thought

# THE *Jilm* DAILY

The Daily Newspaper  
Of Motion Pictures  
Now Fifteen Years Old

VOL. LXII. NO. 77

NEW YORK, FRIDAY, JUNE 30, 1933

5 CENTS

Fox Announces 43 of 54 Titles For Next Season

## "OPEN MARKET" ON EQUIPMENT PARTS

Defer A... Proposed N. Y. Building Code to Fall

Decision Finds Illegal Electrical Research Products Clause Restricting Buying—Producers Win Important Point

In one of the most far-reaching court decisions in the annals of the film industry, Judge John P. Nields of the U. S. District Court, Wilmington, Del., has handed down a decision which allows exhibitors to buy sound reproducer parts in the open market, regardless of their tying agreements with Electrical Research Products, and permits producer licensees to sell their pictures to exhibitors other than those using Western Electric Equipment.

Opinion on Page 9

Fig. 1  
"Exhibit 'A'" In talkies servicing.

### AN INTRODUCTION TO—

# SERVICING THE "TALKIES"

PART I — AARON NADELL

RECENT developments, culminating in a decision handed down in a United States court a few weeks ago, have effectively opened to the radio dealer and Service Man the field of supplying parts to motion picture sound equipment!

It is a profitable field. The radio man who can "line up" three or four local theatres as customers for his electrical parts and his technical knowledge will find he has a very nice side line to add to his radio business. If he can line up six or eight such theatres (possibly all under one ownership) he will find he can afford to consider his radio business a side line. *Approximately 17,000 American theatres are now "wired for sound."*

#### Parts Replacements Charges

Theatres are accustomed to paying prices for their supplies that will remind the radio man of the days of '22 and '23. Sixty dollars for a rectifier tube capable of passing 200 ma. was not an uncommon price until very recently, and some theatres are still paying it. (*Sixty*—not six—dollars.) An average theatre will spend several hundred dollars a year for tubes alone.

These prices fade into comparative unimportance when compared with the cost of replacing a burned-out transformer, or some similar part in an amplifier. Often, in the past, such amplifiers have been returned to the factory for complete overhauling, at a cost of \$100 or more, because of a damaged A.F. transformer, a short-circuited condenser block,

or some similar trouble which the local radio Service Man might easily have repaired, with good profit to himself, *at one-tenth the cost!*

If these prices and practices seem fantastic, it must be understood that to the theatre the sound equipment is its stock in trade, which *must* operate at all costs. Unlike the radio owner, who has no reason to be troubled if his radio is silent for a day or two, the theatre cannot afford to shop around for lowest prices.

The theatre manager, and the projectionist, the two persons who are directly responsible for the performance of the sound equipment are, for reasons which will be explained later, not always technically equipped, by experience or previous training, to understand precisely what repairs are needed in an emergency, or how much those repairs should cost.

Today, by decision of a United States court (see Fig. 1), as well as by certain internal changes (to be described) in the theatre industry itself, the local radio man is at liberty to make those repairs and to sell the necessary parts for them.

That he can do this at excellent profit to himself, and still save the theatre much money, as compared with the prices

it is accustomed to pay, is, to this writer, unquestionable. The only question involved is convincing the manager and the projectionist of that fact.

*There is where the catch comes in.*

Those gentlemen are tough people to convince; and the man who attempts to do it must know very thoroughly just what he is about. He must not only know sound equipment technically (it is very similar to radio equipment) but he must also know show business, and its peculiar requirements. Most important of all, he will need a good and deep insight into the psychology and habits of thought of both the projectionist and the manager, or he'll never get to first base. If he doesn't know how to approach those gentlemen, the fact that actually he can help them and save them money won't mean a thing—as will be seen.

It is proposed in this article and in others to follow, to outline both the technical and the commercial aspects of the new opportunity which is now open to alert radio technicians. At the present moment it may be as well to pause to explain how it is that that opportunity is now open; and why, until very recently, the chances of the local radio man to be of service to his community's theatres were extremely dubious.

Two developments have contributed to the creation of the present set-up. One is the court decision already referred to—handed down by Judge John P. Nields in the U. S. District Court at Wilmington, Delaware; and the other is the breakdown of the large theatre chains.

#### Contracts and the Federal Court

There was only one company equipped and ready to supply the sudden and urgent demand for "talkie" apparatus when talking pictures began, and every theatre in the country was shouting for the necessary equipment "immediately if not sooner." That company naturally got the cream of the business, on their own terms. They did not sell, *they leased*. The terms of the lease provided that the same company was to supply all tubes and other spare parts, no matter how much more cheaply they could be purchased elsewhere. There was also a servicing clause, which will be discussed later but which is of no immediate concern here. It is that leasing contract that the Federal court at Wilmington upset. In consequence any radio man is now free to sell tubes or other supplies to theatres (amounting to about half of all talkie theatres in the country, and including nearly all the larger and wealthier ones) which use that company's electrical equipment. Other legal actions along related lines will be described later in this series.

Until a short while ago the majority of the country's theatres functioned under the chain system, which meant that a thousand or more theatres were, like so many grocery stores, under one ownership, and operated from a central office in New York, Chicago, or some other large city. Purchase of supplies for sound equipment, and supervision of the service such equipment required, were handled by the "home office." Staffs of sound engineers travelled about the country inspecting theatre apparatus, contacting manufacturers, buying tubes and other supplies directly from the

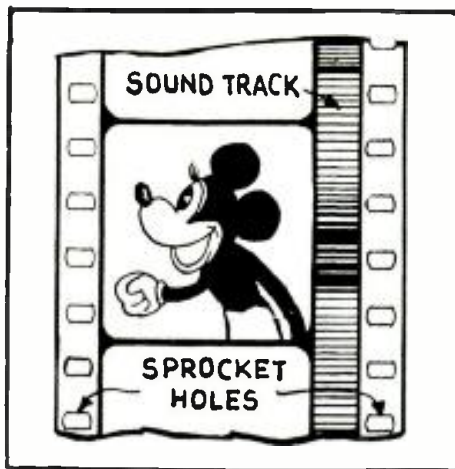

Fig. 2  
A "frame" from a sound-movies film.

## SERVICE MEN

Do you know that there are approximately 17,000 American theatres now "wired for sound"? Do you know that these theatres have been accustomed to paying as high as \$60.00 for a rectifier tube? Do you know that simple service jobs on talking motion picture equipment have cost \$100.00 and more? However, it is only within the last few months that changes within the theatre structure have made it possible for the independent radio Service Man to handle calls for service on talkie equipment. In this and subsequent articles in a new series, Mr. Aaron Nadell, who is an authority in his chosen field, will show the radio Service Man the exact steps necessary to successfully enter a newly opened, highly profitable field—Servicing the Talkies.

fier with ten watts output!

In the articles to follow it is proposed:

(1) To discuss the elementary nature of sound equipment, from a moderately technical point of view. Any experienced radio man will grasp the essentials of this description without the least trouble.

(2) To describe the problems, functions and average psychology of the theatre manager, together with some attention to the unusual nature and problems of theatre enterprise.

(3) To deal with the background, psychology and problems of the average projectionist (without whose co-operation the radio man will get nowhere)—and especially with the exceptionally delicate situation of contacting the unionized projectionist.

(4) To outline, in considerable detail, just how the radio man can offer superior service and assistance to neighboring theatres, and in particular how his peculiar advantages

(Continued on page 302)

factory, and in general leaving no room at all for the local radio man to be of the slightest use. That set-up is now broken down. The large chain proved uneconomical—the overhead ate up the profits—and is everywhere in discredit. Small chains, composed of three, four or a dozen theatres are the backbone of show business today. They constitute the local radio man's most promising prospects. Skeletons of the larger chains still remain, for the most part broken down into smaller operating groups which the radio technician can contact with profit both to himself and to them.

The full story of the recent changes in the theatre industry is more complicated than this brief outline indicates, but the complications will be taken up in detail in their proper place. At this point, enough has been said to point out that an opportunity never before open to him is awaiting the local radio dealer when the show season "opens" this fall and winter, provided he has equipped himself with the necessary knowledge to take advantage of it

#### Forthcoming Articles

It simply will not work to ask for the manager at the box office of the local theatre and offer in some vague way to be helpful in his sound problems. *The radio man who aspires to service and supply his local theatre must know precisely what function he intends to perform.* He must know exactly and in detail how and why his intervention will be advantageous to that manager. More important still, he must know how to make his intervention welcome, and not objectionable, to the projectionist. Lastly, he must learn enough about that very peculiar enterprise, unlike any other, which is called show business, to enable him to interfere in it successfully and without "gumming up the works."

But before everything else, he must know what sound equipment is all about, what it is like and how it differs from ordinary radio equipment. At least enough about sound installations not to become confused when he confronts a rack-full of apparatus reaching from floor to ceiling and is told the whole business is only an audio ampli-

# THE NEWEST DESIGN IN ALL-WAVE

## PART I

McMURDO SILVER\*

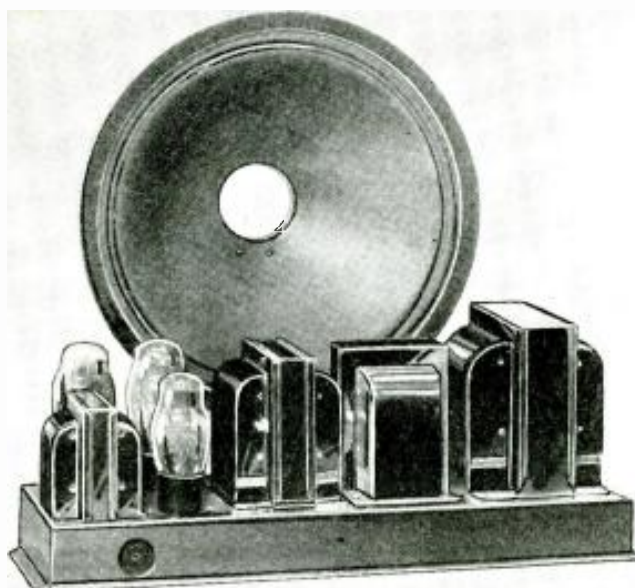
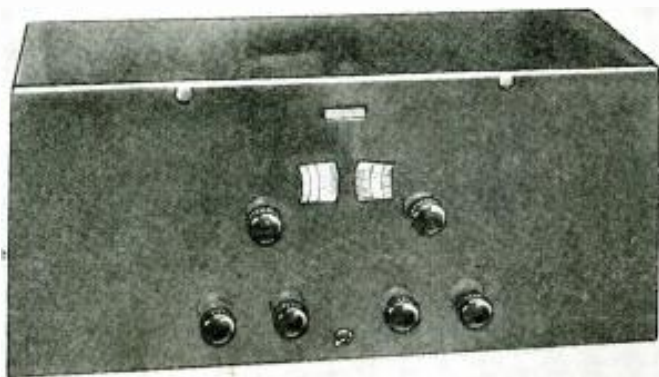

Fig A  
At the left is the complete set in its chromium cabinet while at the right is the power supply, amplifier and speaker.

TO THOSE familiar with the original Masterpiece all-wave superheterodyne receiver two changes are outstanding upon looking at Fig. A. The first is the polished chromium shielding "cabinet" over the entire receiver chassis, shown at the left. This cabinet contributes additional shielding over and above that of the individual circuit elements, helping to eliminate extraneous noise, and also keeping dust and dirt out of the set.

### Simplifying the Tuning

The second change is the use of two tuning dials instead of one. The receiver is completely tuned by the right-hand dial and its single knob, as was the first Masterpiece. The second dial is simply a vernier, or "bandspread" tuning dial to permit the short-wave bands such as the 6,000, 9,500 and 12,000 kc. short-wave bands (which are assigned for broadcast services) to be spread out over a whole full dial scale. It may otherwise be used to spread the four amateur bands—or even small segments of the broadcast band, for easy tuning.

The 28:1 dial ratio used in the first receiver was too slow in operation; even more important, it did not permit sufficient band-spread for easy reading. Using the new band-spread dial, the main tuning dial need only be set at, say, 6.2 for the 6,000 kc. or 50 meter short-wave broadcast band, and all the stations in this band will be found spread out nicely on the vernier dial—for the first time, *actually making short-wave tuning easier than is broadcast band tuning on ordinary receivers.*

Tuning is rendered difficult by any high-ratio tuning dial, which will necessarily be mechanically stiff. By the use of 6:1 automatic take-up gear drives with opposed gears (an equivalent of the beautifully smooth helical gear control) the mechanical operation not only is smooth and entirely free of slippage, wear or backlash, but the control knobs turn with extreme ease. This simple mechanical change is invaluable, and in the hands of a novice can make all the difference between skipping over foreign short-wave stations, and having them actually easier to find than broadcast band

stations!

The control knobs are, looking at the front panel, Fig. A, upper two, the main tuning knob and dial at the right, and the vernier or band spread dial and knob at the left; the visual tuning meter is at the top-center. The four lower knobs are, left to right, audio volume level control, manual tone control; at the lower center, the audio beat oscillator toggle switch, inter-station noise suppressor or sensitivity control, and the four-position, positive-acting wave change switch.

### Sensitivity Control

In any sensitive receiver using an A. V. C. system, sensitivity will rise to a maximum in the absence of a carrier signal, and the local noise is bound to be heard between stations, if a "squelch" circuit is not provided. This is particularly annoying in the daytime, when many channels are bound to be dead, and noise will be heard as the set is tuned between the stations normally heard in the daytime.

The special "squelch" circuit used in the first Masterpiece had two disadvantages. It required an extra tube, and its cut-off level had to be set at some arbitrary point. Also, it was found that many stations constituting good noise-free entertainment, would, in the course of the normal and continuous slight fading, fade across any arbitrarily established cut-off level, resulting in a periodic cut off of reception, or if fading was rapid, in choppy and distorted reception when the squelch circuit was in use.

Therefore, an R.F. sensitivity control has been substituted for the squelch circuit. It can be adjusted to local noise conditions; also, it entirely eliminates the possibility of choppy reception of stations fading slightly across the silent tuning control cut-off level. It permits of adjustment, when desired, of the R.F. and I.F. gain to the exact degree desired, almost wholly independent of the actual loudspeaker volume desired, and over all ordinary operating ranges has no effect on the A. V. C. action, or on the operation of the A.F. volume level control.

Thus the revised tube circuit line-up in the receiver chassis is: a type 58 R.F. stage; a 2A7 combined first detector and electron-coupled oscillator (the first combination tube so far

\*President, McMurdo-Silver, Inc.

# SUPERHETERODYNE RECEIVERS

Since the author started building the Masterpiece 13 to 570 meter custom-built superheterodyne, hundreds of these receivers have gone into use all over the world. Now, one year later, and as a result of analyzing a cross-section of comments and suggestions, an improved instrument has been developed. These improvements are simplifications of an electrical and mechanical nature, calculated to render the results previously obtained easier to secure, both for the novice and the experienced engineer alike.

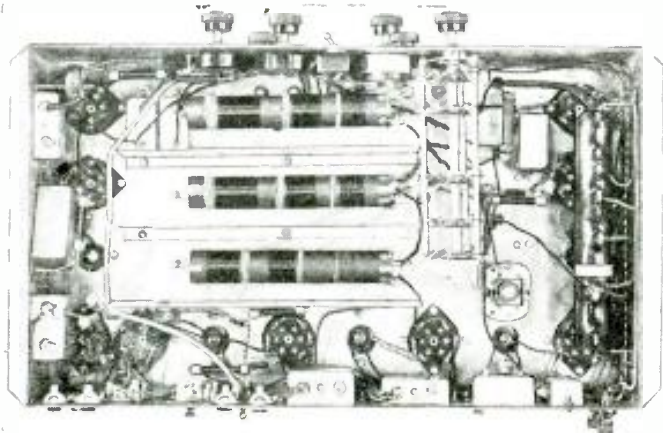

Fig. B  
The under-chassis view of the set coils and band switch.

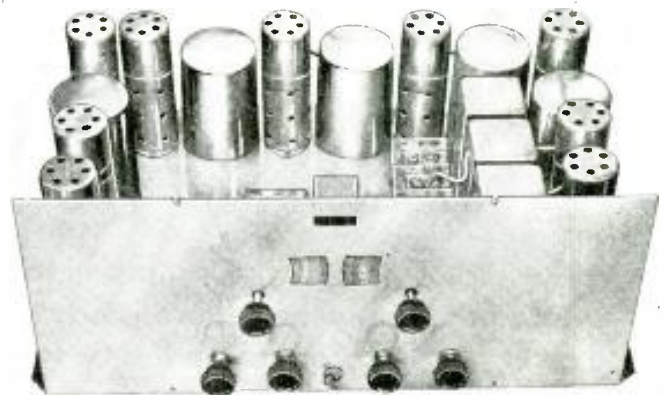

Fig. C  
The band-spread dial on the left simplifies tuning on the short wave bands. An overall metal cabinet entirely eliminates extraneous pickup by the wiring.

introduced which gives actually better results than separate tubes performing the same functions); three type 58 I.F. stages (the third stage used for selectivity, not for gain—its additional gain cannot be used); a 56 first A.F. stage; two type 2A3 tubes connected in push-pull class A, and delivering 15 W. of output power; and a 5Z3 rectifier.

## Changes in the Power Stage

A pair of type 45 power tubes operated in the class A prime system developed in the writer's laboratories was used in the original Masterpiece to produce 10 W. of undistorted output power. Refer to "Pentode, Class B or Triode Audio Systems?" by the writer, in the July, 1932 issue of *RADIO-CRAFT*.) This class A prime development had so much merit that another manufacturer desiring to obtain its result, but loath to bow to the more advanced research work of a competitive laboratory, insisted that RCA develop a larger, straight class A tube to give the same results. The result was the new 2A3 tube, a pair of which when operated in class A connection will turn out 15 W. of undistorted A.F. power at reasonable operating voltages; these tubes possess the advantage of requiring only voltage, not power, from their driving stage; whereas, the 45's in class A prime require power to drive them to full output, hence the use, in the earlier design, of a pair of 56's in push-pull as a power-driver stage. Through the present use of a pair of 2A3's the maximum power output is increased 50%. (this consideration is unimportant, since 10 and 15 W. is less than about 2 db., or the minimum variation ordinarily perceptible to the human ear.) The important point, however, is that the 2A3's require no driving power but may be fed by a single 56 voltage amplifier.

The 15 tubes used in the original receiver's A.F. amplifier and power unit are now seen to be cut to eleven, more efficient ones. Actually, however, the improved and simplified receiver uses 12 tubes, the twelfth tube being a 58 in the added, dual-tuned I.F. stage. This tube is added only because it is the simple and obvious means of coupling the two extra tuned circuits added to the I.F. amplifier to set the selectivity up to absolute 9 kc. instead of absolute 10 kc.,

for 9 kc. selectivity is needed in Europe where broadcast-band stations are separated by 9 kc. instead of 10 kc. as in this country. This does not affect the fidelity unfavorably, which is still flat to 5 db., from 50 to 4000 cycles—better fidelity than is had by any competitive set today available not resorting to excessive A.F. compensation with consequent annoying hiss.

Another change which results in improving the signal-to-noise ratio is the use of the tuned R.F. stage on both broadcast and short waves. This is a development made possible by research work done by the writer in the past year which resulted in the ability to accurately track the tuned R.F. stage with the first-detector and oscillator circuits. *The additional gain of this stage cuts down oscillator hiss* found in other sensitive receivers, and results in the best inherent signal-to-noise ratio so far obtained in any sensitive all-wave radio receiver. It also eliminates the repeat spot or image interference on short waves found, the writer believes, in every other custom-built all-wave set made today.

Separate antenna coupling coils for each of the four bands permit the use of a tuned or transposed antenna or lead-in system.

Still another point of improvement lies in the arrangement of circuit constants to permit the 12,000 kc. short-wave band mostly occupied by foreign stations to fall at the low tuning capacity end of one tuning range. This low C/L ratio circuit gives better signal strength than does a high C/L ratio circuit, making for more consistent and satisfactory reception of 12,000 kc. and 9,500 kc. band foreign stations.

In conclusion, the writer desires to express appreciation to Masterpiece users for their helpful suggestions; and particularly to Professor William Bostwick of Cornell University who, in his search for the ideal all-wave receiver, and in attempting to satisfy the University's rigid requirements, has been of great help in bringing the latest model to its present high state of perfection.

A schematic circuit of this receiver and a more detailed technical discussion will appear in a forthcoming issue of *RADIO-CRAFT*.



Fig. A  
The "revamped" set in use.

# HOW TO CONVERT A.C.-D.C. SETS FOR "DRY-CELL" TUBES

RICHARD  
SILBERSTEIN

The modern A.C.-D.C. ultra-midget radio receiver unfortunately cannot be used in places where there is no power supply — a completely self-contained set is required for use on the beach, in camps, on small craft, and in canoes. The author describes a "converted" receiver which weighs only 12 lbs., complete with batteries, and which can easily be fitted into a knapsack for purposes of transportation. The filament drain from the three tubes is only 180 ma. so that frequent "A" battery renewals are not necessary.

THOSE of us who bought an early 4-tube T.R.F. midget set with a magnetic speaker may have wondered what to do with the old set now that a new 5-tube superheterodyne midget reposes on the living-room table (or ought to!). Here is a way to make the old set perform in a brand new role — entertaining a canoeist, for instance, as illustrated in Fig. A — at the additional cost of only a few tubes, batteries and other small items. Although the description will cover specifically the Emerson Compact set, it applies in general to any of the earlier "universal-current" radio receivers, the primary requirement being a magnetic speaker, which is essential to a light, battery-operated set. A front view of the completed conversion is Fig. B; and a rear view is Fig. C.

Briefly, the conversion consists of substituting a type 32 tube for the 39 in the R.F. stage, another 32 in place of the 36 detector, and a 30 instead of the 38 in the output stage. Coupling between the detector and the audio output stage is accomplished by means of an R.C.A. 700 hy. detector choke. Regeneration is provided in the detector circuit by means of a 50-turn coil coupled to the grid coil. The "converted" circuit to be followed is shown in Fig. 1. Items not labeled are the same as in the original set.

### Step-by-Step Procedure

The first thing to do on the old chassis

is to remove the plate choke, the filament drop resistor and all the electrolytic condensers. Electrolytic condensers have a continuous leakage current and therefore must not be used on sets operated from "B" batteries unless these are disconnected whenever the set is not in use. Nearly all the wiring in the under part of the chassis, except the common negative bias connection of the R.F. coils must be undone. This last can be used as a connection for the 3 V. "C" battery negative.

It is well during this procedure and in fact all through the work, to keep

the R.F. coils wrapped in cloth tied with rubber bands in order to avoid scratching the delicate enamel insulation.

The socket nearest the variable condenser is to be used for the 32 R.F. amplifier tube. Since the bulb and base of the standard type 32 are larger than those of the 39 which it is replacing, it will be found that the variable condenser plates will hit the tube unless the whole unit is moved forward. This is accomplished very conveniently by moving the unit forward a distance equal to the distance between the two mounting screws, namely 1 5/32 ins.

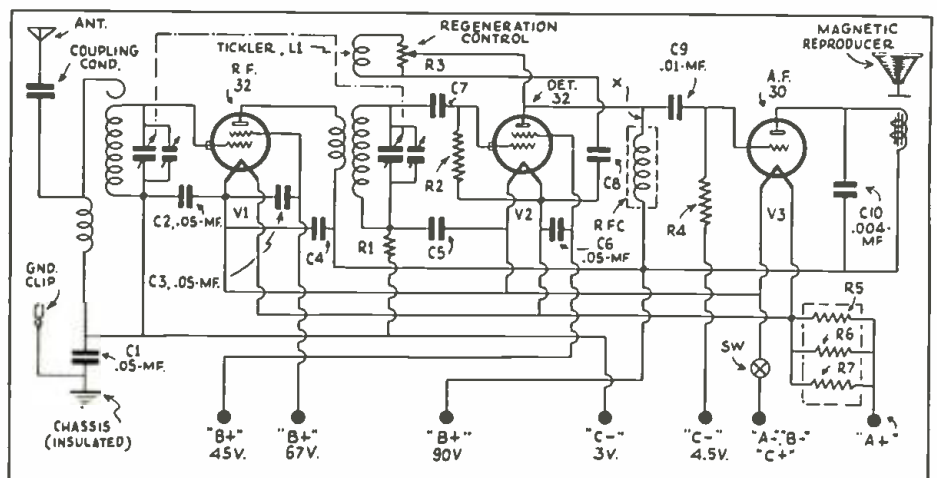

Fig. 1  
The Emerson "Compact," rewired for dry-cell tubes.



It is then necessary to drill only one new hole in the chassis, a  $\frac{1}{4}$ -in. hole at a distance of  $15/32$ -ins. toward the front. Then the condenser is re-mounted with the forward bushing in the new hole and the rear bushing in the hole previously occupied by the forward bushing. In this process the leads to the condenser must be removed and soldered back again.

Now the condenser plates will clear the tube but it may be necessary to hammer in the flange of the loudspeaker frame for a short distance so that the plates may pass without touching. It will be found that the antenna series condenser mounted on the frame of the tuning condenser protrudes past the front of the chassis. This is now removed and placed under the chassis in part of the space formerly occupied by the filament drop resistor.

The 32 detector tube takes the place of the old 36 tube. Instead of the "plate" detection scheme previously used, the "grid-leak and condenser" type was employed in order to obtain higher efficiency on weak signals. The 250 mmf. condenser is mounted under the chassis in the middle of the space formerly occupied by the filament drop resistor and the control-grid lead brought up to the detector tube.

Although the R.C.A. detector plate choke, R.F.C., was the smallest choke of its kind obtainable, no space was found on the chassis into which it could be fitted. Hence it was necessary to mount it outside of the chassis in the battery box. For this reason one must now solder a long, insulated lead onto the plate connection of the detector socket.

#### Adding Regeneration

The regeneration or tickler coil L1 consists of 50 turns of No. 30 enameled wire on a  $7/8$ -in. form. The wire is wound as close as possible to one end of the form so as to secure close coupling to the detector circuit. The coil is mounted directly on top of the detector grid coil. A handy way to do this is to obtain a small piece of fiber about 20 thousandths of an inch thick and cut a strip about  $1/2$ -in. wide. Curl this strip in the manner of a stiff collar and slip it into the end of the regeneration coil so that it protrudes about  $1/4$ -in. above the end all around. A little Duco Household Cement or Ambroid Cement will hold it in place. Now push this assembly into the end of the detector coil, smear a little of the cement onto the fiber and permit to dry for a short time.

To provide for regeneration control, remove the volume control potentiometer and substitute a 20,000 ohm potentiometer with an off-on switch, connecting it into the circuit across L1 as shown in the diagram. The off-on switch breaks the negative filament circuit.

The 30 audio tube is mounted in the space formerly occupied by the 37 rectifier. (It would have been possible to put a fourth tube in the space formerly

occupied by the 38 but this was not done because experiments with a fourth tube gave poor results.) Two type 30 tubes in parallel gave a slightly weaker and more distorted signal than one, probably because their combined plate impedances did not match the speaker impedance. An additional stage of resistance coupled amplification was abandoned because of detector tube microphonics.

The chassis is left free as in the original set, being tied to the negative end of the 3 V. battery only by means of a .05-mf. condenser. This is better than making a direct connection since it minimizes the chance of a short-circuit while the set is being tested.

In "universal" or A.C.-D.C. sets the ground connection is made through the power line, but since there is no power line in a battery set it is necessary to have an actual ground connection, or else a "counterpoise" consisting of about 25 ft. of wire, for use in places where a good ground is not to be had. This ground or counterpoise is connected directly to the chassis when the set is in use.

The filament current is controlled by means of special ballast-resistor cartridges. Space limitations required that these also be carried in the battery box and to minimize the number of connecting wires they are arranged in parallel.

For the preliminary test and for final mounting, eight leads must be brought out from the chassis through the perforations at the rear. (These leads are clearly shown in the rear and underside views of the chassis, Figs. D. and E, respectively.) They are the seven battery leads shown in Fig. 1 and one more lead, X (from the detector plate), for the R.F. choke. The other end of the choke goes directly to the "B+" 90 V. tap in the battery box.

#### The Power Supply

For the sake of portability it was decided to use only 90 V. of "B" battery. The smallest batteries obtainable are 45 V. units made by a company in Cleveland, Ohio. The batteries measure  $3\frac{3}{4} \times 2\frac{1}{4} \times 3\frac{1}{8}$  ins. The same company makes a 3 V. "A" battery having dimensions of  $3\frac{1}{2} \times 1\frac{3}{4} \times 4\frac{3}{4}$  ins. For the 3 V. "C" battery a small flashlight battery was used; for the  $4\frac{1}{2}$  V. "C" battery another type was employed, although a flashlight battery would have been satisfactory in this position.

The battery box can be made to suit the individual's "taste." One method would be to have a separate battery box joined by a multi-colored cable to the main outfit. In this set the battery box was built of  $1/8$ -in. pine directly onto the set, using the bottom of the cabinet as the top of the battery box. The four bolts which pass through the bottom of the cabinet to hold the chassis in place were used to hold four 1 in. brass angles to which were bolted the ends of the box, measuring 4 ins. along the cabinet bottom by  $4\frac{1}{2}$  ins. deep. Around

(Continued on page 301)



BATTERY BOX

Fig. B  
Front view of the completed instrument.

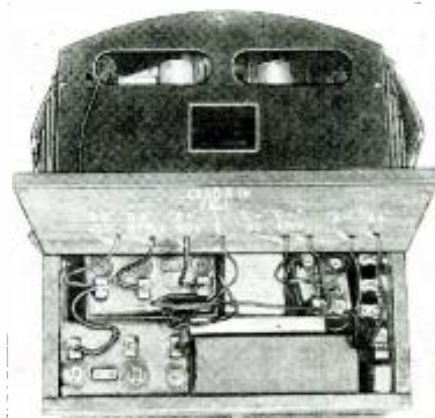

Fig. C  
Lead connections to the batteries.

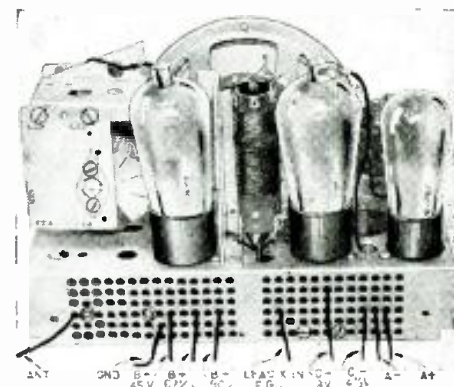

Fig. D  
Rear view of the battery-type ultra-midget.

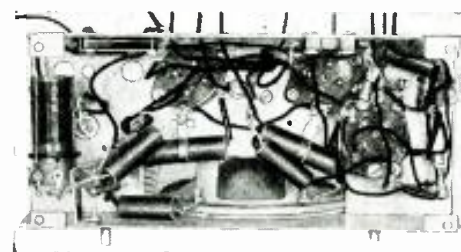

Fig. E  
Underview of the altered chassis.

# HOW TO MAKE YOUR OWN TRANSFORMERS AND CHOKES

PART I

LESTER H. CARR\*

**T**RANSFORMERS are only as good as their poorest feature, both in design and construction. It is very important to take great pains not only in designing and laying out a transformer but also to use equal skill in its construction.

Since the subject of design has been covered quite thoroughly in previous issues of *RADIO-CRAFT* only a few of the important points of design will be reviewed. For maximum efficiency in operation, the core loss of any transformer should equal its copper loss, the ratio of the weight of iron to the weight of copper in the average power transformer, using a high grade of steel, being approximately  $8\frac{1}{2}$ . The allowable current density in the copper for continuous operation is between 1300 and 1500 c.m. (circular mils.) per ampere. Due to the fact that the eddy current loss in the conductors increases as the square of the thickness of the wire, it is not advisable to use wire much larger than necessary, if this loss is to be kept at a minimum. However, this is more important in reactors (choke coils) than in transformers. The hysteresis loss in the core varies as  $B^{1.6}$  and  $f$ , where  $B$  is the flux density and  $f$  is the frequency of the current. The eddy current loss varies with  $B^2$ ,  $f^2$ , and  $t^2$ , where  $t$  is the thickness of the laminations. From this it can be seen that to keep down the losses in the core the flux density should be kept down within limits and also the laminations should be very thin, usually 26 or 28 gauge.

## Good Construction Design

Now let us turn to the construction proper. First, the cutting of the transformer steel should be done with sharp and close-fitting tools to prevent dragging the edges. If this is not done the turned edges will break through the oxide scale on the adjoining laminations and cause a large increase in the eddy current loss. Care should be taken not to injure the oxide coating of the steel by bending or chipping as this oxide affords the only insulation to the eddy currents, unless the laminations are dipped in an insulating varnish. Usually this is not necessary except in the need of special construction or in

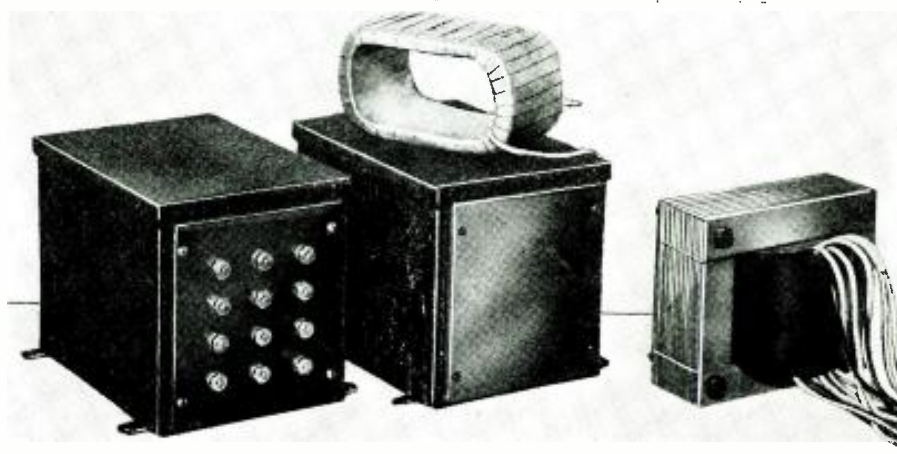

Fig. A  
A low-power transformer, showing primary electrostatic shielding tape.

case of a poor oxide coating. In the event that an additional insulator is used only a very thin coat should be applied. This is done by dipping the laminations in a thin solution of insulating varnish or its equivalent. In building up the core it is inadvisable to use butt joints and it should be interleaved with as few joints as possible. In small units it is possible to stamp out the laminations, although in the larger sizes it is usually necessary to build up the core from strips. In either case, even interleaving is used to keep the reluctance of the joints as low as possible. If the reluctance of the core is increased very much by poor joints, the magnetic leakage in the windings will increase, resulting in poor transformer regulation.

A very important rule to remember in both design and construction is that the mean turn length of both the steel and the copper should be kept at a minimum; from which one deduces that the ratio of the space occupied by the copper to the total winding space should be as large as possible. This ratio is known as the *space factor*.

## Coil-Winding Details

It is highly desirable to use "pi" windings wherever possible, because of better insulation, cooling and symmetry in tapping. Care should also be used in selecting insulating material for the

windings. Light material having a high dielectric strength is preferred. If heavy insulation is used or if too much is put in the windings, hot spots will be present due to the poor heat conductivity from the inner portion of the coils. This may prove as disastrous as under-insulating, due to the insulation carbonizing from the heat and breaking down. On narrow coils heavier insulation can be used without this danger and is to be favored due to the strengthening of the winding. If the windings are to be impregnated (and all high grade transformer windings should be) cotton tape is used to wrap the coils. This makes a good binder for the impregnating compound. The winding is then placed in a vat and heated, the air pressure being *reduced* to help draw out all moisture. The coil is then placed in hot resin compound and the pressure *raised* to drive the impregnator well throughout the winding. It is then wrapped with empire cloth for additional external insulation. By impregnating not only is the insulating quality increased but the coil is strengthened greatly which prevents insulation rupture due to stress on the winding at times of sudden shock loads or short-circuits.

Mica is often used as an insulator between primary and secondary windings because of the necessity of having close proximity of the primary and

\* Consultant Engineer, Franklin Transformer Company.

Although past issues of RADIO-CRAFT have contained considerable information concerning the design and construction of power transformers and chokes, and A.F. transformers and chokes, a good part of this information has been entirely theoretical; and previously published practical data in many instances has not taken into consideration the newest "tricks" as used by manufacturers. Consequently, this article by Mr. Lester H. Carr will be of exceptional interest, since it combines both the theoretical and practical viewpoints in the design and construction of units in power and A.F. circuits.

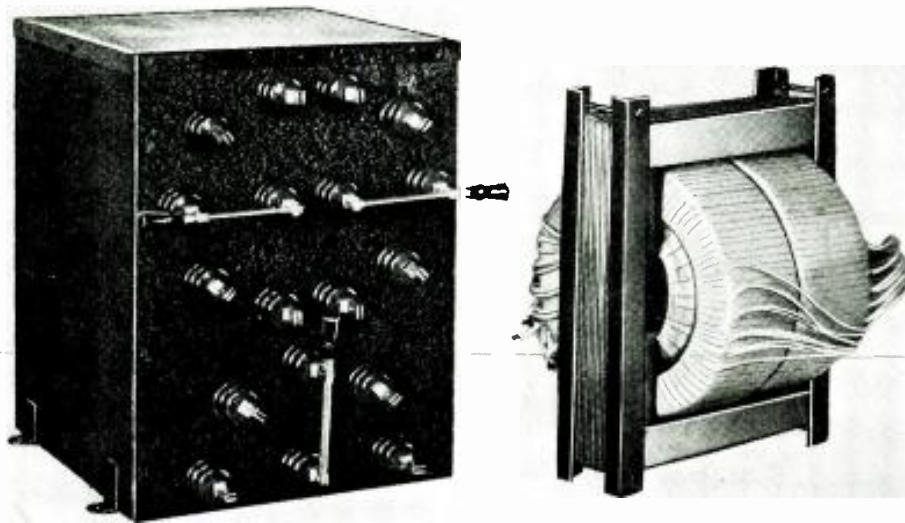

Fig. B  
A medium-power transformer. The primary and secondary windings are tapped.

secondary windings if magnetic leakage is to be kept low.

The leakage reactance caused by this leakage flux is equivalent to an inductance added in series with the primary, and, consequently, greatly impairs the voltage regulation of the transformer. A design feature is to enclose the primary winding in copper foil, care being taken not to have a short-circuiting turn. (Opening up the foil in one or more places and insulating will safeguard against any trouble of this kind.) If the transformer is used where there are any R.F. currents which might leak into the windings, this shielding prevents it from getting into the low-voltage primary where there would be danger of its rupturing the insulation and rendering the transformer useless.

#### Commercial Transformers

Figure A shows a low-voltage type of unit having several secondary windings, and having a shielded primary. A primary winding is shown, illustrating the manner of enclosing the coil in copper. The steel case, illustrated, effectively short-circuits any stray flux from the transformer which would tend to interfere with other equipment. It might be mentioned that *primary shielding of radio receiver power transformers is highly desirable where electrostatic interference often tends to feed into the*

*set from the power lines.*

Figure B shows a flexible design of high-voltage power supply transformer with variable taps on both the primary and secondary for voltage adjustments. The clamping manner of holding the core of the high-voltage unit is preferable to the method used in the unit illustrated in Fig. A. When the method of clamping with a bolt through the core is used, small brass bolts with bushings should be used to minimize the eddy current loss.

Some of the above steps, employed in high-grade transformer manufacturing, may be impractical for the reader to use in building up individual units. It is, however, possible to use more simple methods which will produce good transformers if exceptional care is taken.

#### Home-Built Transformers

For those wishing to build up a special transformer or to rebuild a burned out one, let us cover a simplified construction.

It is advisable to obtain the core from a reliable house to insure a good grade of steel. Either obtain it all ready cut to shape, or take the sheet steel to a tin shop and have it cut or stamped out; however, you will save time and money by purchasing stamped laminations. In case an old discarded or burned-out transformer of the right size is avail-

able, its core may be used. Figure 1 shows a standard "shell" type of stamped lamination commonly used; also it shows how the core is built up from the laminations by reversing each adjoining piece. Once the core size is known, work can be started on winding the coils. The cross-section of the core, "Core Sq. In. X-Section," in Table I is obtained by multiplying the dimensions selected for measurements A and B in Fig. 1.

Make a winding form out of a piece of soft wood whose outside dimensions are approximately  $\frac{1}{8}$  in. larger than the core piece. (This is to allow for insulation between the coil and core.) The piece of wood is cut to a length suitable for mounting in a winding jig or lathe. If such facilities are not available the turning can be done by hand with a little additional help. The block should be waxed or varnished so that the coil will slip off easily after the winding has been completed. Wrap a couple of layers of empire cloth or tough paper around the form and hold in place with a small piece of adhesive tape. Cut a piece of cotton or friction tape  $1\frac{1}{2}$  or 2 ins. long and lay it lengthwise on the form at the end where the winding is to start so that the first turn is nearly in the middle of the strip. Wind two turns and then double back the loose end of the tape outside the first turn, pulling it tightly over the two turns and continue the winding over the two layers of tape. This binds the first two turns, preventing them from slipping. This procedure is used on each layer and at both sides of the coil. After the first layer is wound, wrap one layer of thin, tough paper which has been boiled in paraffin over

(Continued on page 306)

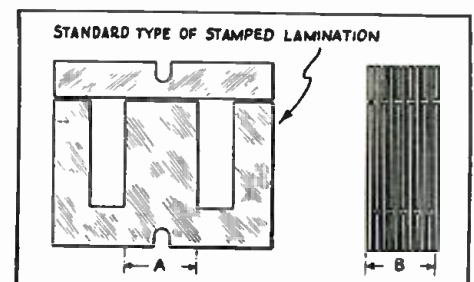

Fig. 1  
"Shell-type" core laminations.

# CONSTRUCTING A COMPLETE 26-WATT, DUAL CHANNEL P. A. SYSTEM

## PART III

Detailed data in reference to the input mixer, 2-speed phonograph turntable, turntable power supply, dual-field dynamic reproducer, and the reproducer field coil exciter required to complete the optional power line or battery 26 W. amplifier. This concludes the series.

LOUIS GANCHER\*

THE man who is looking forward to making a couple of extra dollars in the P.A. field by building and using the universal 6 V., D.C., and 110 V., A.C., 26 W. portable P.A. system discussed in previous installments of this series, has only a few more points to consider and then he may write "finis" to his acquisition of the necessary apparatus. For, it will be recalled, the system is based on the use of a number of inter-locking units, not all of which have as yet been described. This will be evident by reference to Part I, in the September, 1933 issue, where the complete system is shown mechanically locked together, in Fig. C, and "strewn about," ready for business, in Fig. A (the manner in which the complete P.A. system is electrically connected is shown in the block diagram, Fig. 3).

"Checking up," we find that detailed data is lacking in connection with the following units: the input mixer, the 2-speed phonograph turntable, the turntable power supply, the dual-field dynamic reproducers, and the exciter for the high-resistance fields of these reproducers when they are operating on 110 V., A.C.

### The Input 'Mixer' Control Box

For a portable P.A. system to be truly versatile it must be capable of attenuating, accentuating, fading and mixing voice, phonograph and radio programs. To secure these effects in

\* President, Coast-to-Coast Radio Corp.

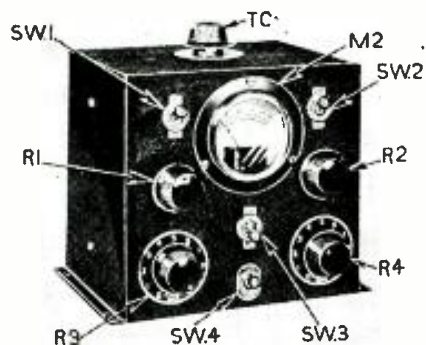

our 26 W., dual-channel P.A. system, the unit illustrated in Fig. F has been designed.

By reference to Fig. 7, the schematic circuit employed in this mixer, it will be seen that the 2-button microphone, M1, is connected to a polarized, 3-way male plug, PP1, which may be conveniently inserted or removed from the polarized, 3-way female outlet, PP2, mounted on the rear of the control unit. Each of these double-button microphone circuits are connected through their respective microphone current controls, R1 and R2, and microphone current reading switches Sw.1 and Sw.2.

Snap Sw.1 to the ON position and adjust R1 for an approximate reading of 8 to 12 ma. Then, to the OFF position; repeat the procedure using R2 and Sw.2. The S.P.S.T. battery switch, Sw.3, opens the circuit of battery B1 when not in use. (Two similar, 100 ohm single-button microphones may also be used with this system for remote dual pickup by connecting them in series as shown at A in Fig. 7, and using an additional, polarized male plug identical to PP1.

The output of the microphone transformer, T1, is connected to the modified "T" pad type constant impedance control, R3, which provides for the complete attenuation of the microphone input signal while maintaining a constant output impedance.

Two phono. input binding posts, BP1 and BP2, mounted on the rear of the case, are connected to the primary of the tapped, phono. pickup input transformer, T2. Two additional terminals,

BP3 and BP4, also located on the rear of the case, are used to couple radio tuners through the control box into the amplifier. A selector switch, Sw.4, feeds the output of either the phono. pickup or radio tuner units into the volume control, R3, leaving the microphone available, in either instance, for impromptu operation. Thus, by manipulating both volume controls, R3 and R4, separately or simultaneously, the microphone input signal may be mixed or faded onto a phono. record or radio tuner program. The tone control, TC, modifies any undesirable defects of the input signal and permits the "mixed" signals to be compensated to best advantage.

Two wires leading from the output posts, BP5 and BP6, are the only necessary interconnecting links between the control box and the amplifier. A single shielded wire, up to 50 ft. in length, may be used to connect the output of the control box to the input terminals of the amplifier, the outside metallic shield itself acting as one of the terminals and ground at the same time.

All of the controls and equipment, with the exception of the 4½ V. "C" battery, are housed in a No. 18 gauge, crackle-finished steel case, 6 x 5½ x 6 ins. high.

### The Two-Speed Phonograph

In order to make the entire system operative from either 110 V., A.C., or from a 6 V. storage battery, particularly for use in sound trucks, automobiles,

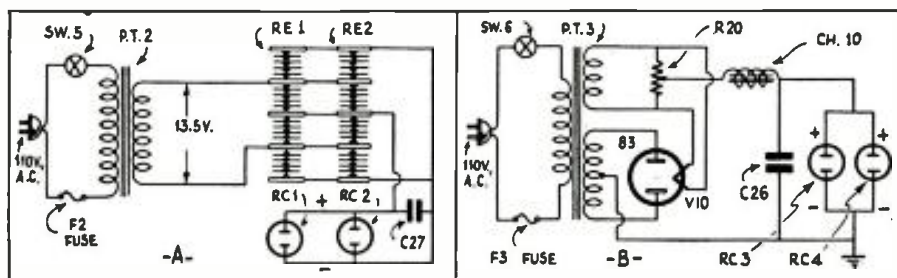

Fig. F, left; Fig. 8, above

At the left, in Fig. F, is illustrated the input mixer. Its circuit connections are shown in Fig. 7, on the following page. Above, in Fig. 8, are shown in A and B the phonograph turntable and dynamic reproducer field coil power supplies pictured in Figs. H and I, respectively.



# BROADCAST STATIONS OF THE U. S.

A list of all the broadcast stations in the U. S. as licensed by the Federal Radio Commission and brought up to date to Aug. 15, 1933.  
Abbreviations: T, location of transmitter; C. P., construction permit authorized; LS, power until local sunset.

Call Letters	Location	Power (watts)	Freq. (kc.)	Wave-length (meters)	Call Letters	Location	Power (watts)	Freq. (kc.)	Wave-length (meters)	Call Letters	Location	Power (watts)	Freq. (kc.)	Wave-length (meters)
KABC	San Antonio, Tex.	100	1420	211.3	KGER	Long Beach, Calif.	1kw	1360	220.6	KOY	Phoenix, Ariz.	1kw-LS	1390	215.8
KALE	Portland, Ore.	500	1300	230.8	KGEZ	Kalispell, Mont.	100	1310	229	KPCB	Seattle, Wash.	100	650	462
KARK	Little Rock, Ark.	250	890	337.1	KGFF	Shawnee, Okla.	100	1420	211.3	KPJM	Prescott, Ariz.	100	1500	200
KASA	Elk City, Okla.	100	1210	247.9	KGFG	Oklahoma City, Okla.	100	1370	219	KPO	San Francisco, Calif.	5kw	680	441
KBPS	Portland, Ore.	100	1420	211.3	KGFI	Corpus Christi, Tex.	100	1500	200		T-Near Belmont	C.P.50kw		
KBTM	Paragould, Ark.	100	1200	250	KGFI	Los Angeles, Calif.	100	1200	250	KPOF	Denver, Colo.	500	880	341
KCMC	Texarkana, Ark.	100	1420	211.3	KGFI	Moorehead, Minn.	100	1500	200	KPPC	Pasadena, Calif.	50	1210	247.9
KCRC	Endicott, Okla.	100	1370	219	KGFL	Hatton, N. Mex.	100	1370	219	KPQ	Wenatchee, Wash.	100kw	1500	200
KCRJ	Jerome, Ariz.	100	1310	229	KGFL	T-Roswell				KPRC	Houston, Tex.	1kw	920	326
KDB	Santa Barbara, Calif.	100	1500	200	KGFW	Kearney, Nebr.	100	1310	229		T-Sugarland	2 1/2 kw-LS		
KDFN	Casper, Wyo.	500	1410	208.3	KGFX	Pierre, S. D.	200	630	476	KQV	Denver, Colo.	500	1380	217.4
KDKA	Pittsburgh, Pa.	50kw	980	306	KGGA	San Francisco, Calif.	100	1420	211.3	KQW	San Jose, Calif.	500	1010	297
	T-Saxonburg				KGGF	Coffeyville, Kans.	500	1010	297	KRE	Berkeley, Calif.	100	1370	219
KDLR	Devils Lake, N. D.	100	1210	247.9	KGGM	T-S. Coffeyville, Okla.				KREG	Santa Ana, Calif.	100	1500	200
KDYL	Salt Lake City, Utah	1kw	1290	232.6	KGHN	Albuquerque, N. M.	250	1230	243.9	KRGV	Harlingen, Tex.	500	1260	238.1
KECA	Los Angeles, Calif.	1kw	1430	209.8	KGHF	Pueblo, Colo.	250	1320	227.3	KRKD	Los Angeles, Calif.	500	1120	267.9
KEIW	Burbank, Calif.				KGHI	Little Rock, Ark.	100	1200	250	KRLD	Dallas, Tex.	10kw	1040	288.5
KELW	Burbank, Calif.	500	780	385	KGHL	Billings, Mont.	1kw	950	316	KRMD	Shreveport, La.	100	1310	229
KERN	Bakersfield, Calif.	100	1200	250	KGIR	Butte, Mont.	500	1360	220.6	KROW	Oakland, Calif.	500	930	323
KEX	Portland, Ore.	5kw	1180	254.2	KGIW	Trinidad, Colo.	100	1420	211.3		T-Richmond	1kw-LS		
KFAB	Lincoln, Nebr.	5kw	770	390		T-Alamosa				KRSC	Seattle, Wash.	100	1120	267.9
KFAC	Los Angeles, Calif.	1kw	1300	230.8	KGIX	Las Vegas, Nev.	100	1420	211.3	KSAC	Manhattan, Kans.	500	580	517
KFBB	Great Falls, Mont.	1kw	1280	234.4	KGJZ	Grant City, Mo.	100	1500	200	KSCJ	St. Paul, Iowa	1kw	1330	225.6
KFBI	Abilene, Kans.	5kw	1050	285.7	KGKB	Tyler, Tex.	100	1500	200	KSD	St. Louis, Mo.	500	550	545
	T-Milford				KGKL	San Angelo, Tex.	100	1370	219	KSEI	Pocatello, Idaho	250	900	333
KFBK	Sacramento, Calif.	100	1310	229	KGKO	Wichita Falls, Tex.	250	570	526	KSL	Salt Lake City, Utah	50kw	1130	265.5
KFBL	Everett, Wash.	50	1370	219	KGKY	Scottsbluff, Nebr.	100	1500	200		T-Saltair			
KFDM	Beaumont, Texas	500	560	536	KGMB	Honolulu, Hawaii	250	1320	227.3	KSO	Des Moines, Iowa	100	1370	219
KFDY	Brookings, S. D.	1kw	550	545	KGNE	North Platte, Nebr.	500	1430	209.8	KSOO	Sioux Falls, S. D.	1kw	1110	270.3
KFEL	Denver, Colo.	500	920	326	KGNO	Dodge City, Kans.	250	1340	223.9	KSTP	St. Paul, Minn.	25kw-LS	1460	205.5
	T-Edgewater				KGO	San Francisco, Calif.	7 1/2 kw	700	380		R-Radio Center			
KFEQ	St. Joseph, Mo.	2 1/2 kw	680	441		T-Oakland				KTAB	San Francisco, Calif.	1kw	560	536
KFGQ	Boone, Iowa	100	1310	229	KGRS	Amarillo, Tex.	1kw	1410	212.8		T-Oakland			
KFH	Wichita, Kans.	1kw	1300	230.8	KGU	Honolulu, Hawaii	2 1/2 kw	750	400	KTAR	Phoenix, Ariz.	500	620	484
KFI	Los Angeles, Calif.	50kw	640	469	KGVO	Missoula, Mont.	100	1200	250	KTAT	Fort Worth, Tex.	1kw	1240	241.9
	T-Buena Park				KGW	Portland, Me.	1kw	620	484		T-Birdville			
KFIO	Spokane, Wash.	100	1120	267.9		T-Faloma				KTBS	Shreveport, La.	1kw	1450	206.9
KFIZ	Pond du Lac, Wis.	100	1420	211.3	KGZ	Olympia, Wash.	100	1210	247.9	KTFI	Twin Falls, Idaho	1kw-LS	1240	241.9
KFJB	Marshalltown, Iowa	100	1200	250	KHJ	Los Angeles, Calif.	1kw	900	333	KTHS	Hot Sp. Nat. Pk, Ark.	10kw	1040	288.5
KFJI	Klamath Falls, Ore.	100	1210	247.9	KHQ	Spokane, Wash.	1kw	590	509	KTM	Los Angeles, Calif.	500	780	385
KFJM	Grand Forks, N. D.	100	1370	219	KICA	Clovis, N. M.	100	1370	219		T-Santa Monica	1kw-LS		
KFJR	Portland, Ore.	500	1300	230.8	KICK	Carter Lake, Iowa	100	1420	211.3	KTRH	Houston, Tex.	500	1120	267.9
KFJZ	Forth Worth, Tex.	100	1370	219	KID	Idaho Falls, Idaho	250	1320	227.3	KTSA	San Antonio, Tex.	1kw	1290	232.6
KFKA	Greeley, Colo.	500	880	341	KIDO	Boise, Idaho	1kw	1350	222.2	KTSM	El Paso, Tex.	100	1310	229
KFKU	Lawrence, Kan.	500	1220	245.9	KIDW	Lamar, Colo.	100	1420	211.3	KTW	Seattle, Wash.	1kw	1220	245.9
	T-Tonganoxie				KIEM	Eureka, Calif.	100	1210	247.9	KUJ	Walla Walla, Wash.	100	1370	219
					KIEV	Glendale, Calif.	100	850	353	KUMA	Yuma, Ariz.	100	1420	211.3
KFLV	Rockford, Ill.	500	1410	212.8	KIFH	Juneau, Alaska	100	1310	229	KUOA	Fayetteville, Ark.	1kw	1260	238.1
KFNF	Shenandoah, Iowa	500	890	337	KIGY	Lowell, Ariz.	100	1200	250	KUSO	Yermillion, S. D.	500	890	337
KFOR	Lincoln, Nebr.	100	1210	247.9	KIT	Yakima, Wash.	100	1310	229	KVI	Tacoma, Wash.	500	570	526
KFOX	Long Beach, Calif.	1kw	1250	240	KJBS	San Francisco, Calif.	100	1070	280.4		T-Des Moines			
KFPL	Dubin, Tex.	100	1310	229	KJR	Seattle, Wash.	5kw	970	309	KVL	Seattle, Wash.	100	1370	219
KFPM	Greenville, Tex.	15	1310	229	KKCN	Blytheville, Ark.	100	1290	232.6	KVOA	Tucson, Ariz.	500	1260	238.1
KFPW	Ft. Smith, Ark.	100	1210	247.9	KKLS	Kulo, Utah	500	1400	214.3	KVOO	Tulsa, Okla.	5kw	1140	263.2
KFPY	Spokane, Wash.	1kw	1340	223.9	KKLM	Minot, N. D.	250	1240	241.9	KVOR	Colorado Spgs., Colo.	1kw	1270	236.2
KFQD	Anchorage, Alaska	250	600	500	KKRA	Little Rock, Ark.	1kw	1390	215.8	KVOS	Bellingham, Wash.	100	1200	250
KFRK	San Francisco, Calif.	1kw	610	492	KKLS	Oakland, Calif.	250	1440	208.3	KWCR	Cedar Rapids, Iowa	100	1420	211.3
KFRU	Columbia, Mo.	500	630	476	KKLUF	Galveston, Tex.	100	1370	219	KWEA	Shreveport, La.	100	1210	247.9
KFSD	San Diego, Calif.	1kw	600	500	KKLX	Oakland, Calif.	1kw	880	341	KWFF	Hilo, Hawaii	100	1210	247.9
KFSG	Los Angeles, Calif.	500	1120	267.9	KKLZ	Denver, Colo.	1kw	560	536	KWG	Stockton, Cal.	100	1200	250
KFUO	Clayton, Mo.	500	550	545	KMA	Shenandoah, Iowa	500	930	323	KWJJ	Portland, Ore.	500	1060	283
KFVD	Los Angeles, Calif.	250	1000	300	KMAC	San Antonio, Tex.	100	1370	219	KWK	St. Louis, Mo.	1kw	1350	222.2
KFVS	Cape Girardeau, Mo.	100	1210	247.9	KMBC	Kansas City, Mo.	1kw	950	316		T-Kirkwood			
KFWB	Hollywood, Calif.	1kw	950	316		T-Independence				KWKC	Kansas City, Mo.	100	1370	219
KFWF	St. Louis, Mo.	100	1200	250	KMED	Medford, Ore.	100	1310	229	KWKH	Shreveport, La.	10kw	850	353
KFWI	San Francisco, Calif.	500	930	323	KMJ	Fresno, Calif.	500	580	517		T-Kennonwood			
KFXD	Nampa, Idaho	100	1200	250	KMLB	Monroe, La.	100	1200	250	KWLC	Decorah, Iowa	100	1370	236.2
KFXF	Denver, Colo.	500	920	326	KMMJ	Clay Center, Neb.	1kw	740	405	KWSC	Pullman, Wash.	1kw	1220	245.9
KFXJ	Grand Junction, Colo.	100	1200	250	KMO	Tacoma, Wash.	250	1330	225.6	KWWG	Brownsville, Tex.	500	1260	238.1
KFXM	San Bernardino, Calif.	100	1210	247.9	KMOX	St. Louis, Mo.	50kw	1090	275.2	KXA	Seattle, Wash.	250	760	395
KFXR	Oklahoma City, Okla.	100	1310	229	KMPC	Beverly Hills, Calif.	500	710	423	KXL	Portland, Ore.	100	1420	211.3
KFYO	Lubbock, Tex.	100	1310	229	KMTR	Los Angeles, Calif.	500	570	526	KXO	El Centro, Calif.	100	1500	200
KFYR	Bismarck, N. D.	1kw	550	545	KNOW	Austin, Tex.	100	1500	200	KXRO	Aberdeen, Wash.	100	1310	229
KGA	Spokane, Wash.	5kw	1470	204.1	KNX	Los Angeles, Calif.	25kw	1050	285.7	KXYZ	Houston, Tex.	250	1440	208.3
KGAR	Tucson, Ariz.	100	1370	219	KOA	Denver, Colo.	12 1/2 kw	830	361	KYA	San Francisco, Calif.	1kw	1230	243.9
KGB	San Diego, Calif.	1kw	1330	225.6	KDAC	Corvallis, Ore.	1kw	550	545	KYW	Chicago, Ill.	10kw	1020	291.1
KGBU	Ketchikan, Alaska	500	900	333	KOB	Albuquerque, N. M.	10kw	1180	254.2		T-Bloomingdale Twp.			
KGBX	Springfield, Mo.	100	1310	229	KOCW	Chickasha, Okla.	250	1400	214.3	WAAB	Boston, Mass.	500	1410	212.8
KGBZ	York, Nebr.	500	930	323	KOH	Reno, Nev.	500	1380	217.4		T-Quincy			
KGCA	Decorah, Iowa	100	1270	236.2	KOIL	Councils Bluffs, Iowa	1kw	1260	238.1	WAAF	Chicago, Ill.	500	920	326
KGCR	Watertown, S. D.	100	1210	247.9	KOIN	Portland, Ore.	1kw	940	319	WAAM	Newark, N. J.	1kw	1250	240
KGCU	Mandan, N. D.	250	1240	241.9	KOL	Seattle, Wash.	1kw	1270	236.2	WAAT	Jersey City, N. J.	500	940	319
KGCX	Wolf Point, Mont.	100	1310	229	KOMA	Oklahoma City, Okla.	5kw	1480	202.7	WAAW	Omaha, Neb.	500	660	435
KGDE	Fergus Falls, Minn.	100	1200	250	KOMO	Seattle, Wash.	1kw	920	326	WABC	New York, N. Y.	50kw	860	349
KGDM	Stockton, Calif.	250	1100	272.7	KONO	San Antonio, Tex.	100	1370	219	WBOQ	T-Wayne, N. J.			

Call Letters	Location	Power (watts)	Freq. (kc.)	Wave-length (meters)	Call Letters	Location	Power (watts)	Freq. (kc.)	Wave-length (meters)	Call Letters	Location	Power (watts)	Freq. (kc.)	Wave-length (meters)
WADC	Tallmadge, Ohio	1kw	1320	227.3						WHN	New York, N. Y.	250	1010	297
WAGM	Presque Isle, Maine	100	1420	211.3	WDZ	Tuscola, Ill.	100	1070	280.4	WHOM	Jersey City, N. J.	250	1450	206.9
WAIU	Columbus, Ohio	500	640	469	WEAF	New York, N. Y.	50kw	660	455	WHP	Harrisburg, Pa.	500	1430	209.8
WALR	Zanesville, Ohio	100	1210	247.9							T-Lemoyne	1kw-LS		
WAMC	Anniston, Ala.	100	1420	211.3	WEAN	Providence, R. I.	250	780	385	WIAS	Ottumwa, Iowa	100	1310	229
WAML	Laurel, Miss.	100	1310	229	WEAD	Columbus, Ohio	750	570	526	WIBA	Madison, Wis.	500	1280	234.4
WAPI	Birmingham, Ala.	5kw	1143	263.2	WEBC	Superior, Wis.	1kw	1290	232.6	WIBG	Glenside, Pa.	25	950	323
WARD	Long Island Cy, N. Y.	500	1400	214.3	WEBQ	Harrisburg, Ill.	100	1210	247.9		T-Elkins Park			
WASH	Grand Rapids, Mich.	500	1270	236.2	WEBR	Buffalo, N. Y.	100	1310	229	WIBM	Jackson, Mich.	100	1370	219
WAWZ	Zarephath, N. J.	250	1350	222.2	WECD	Chicago, Ill.	100	1210	247.9	WIBU	Poyntette, Wis.	100	1210	247.9
WAZL	Hazleton, Pa.	100	1420	211.3	WEED	Greenville, N. C.	100	1420	211.3	WIBW	Topeka, Kans.	1kw	580	517
WBAA	W. Lafayette, Ind.	500	1400	214.3	WEEL	Boston, Mass.	1kw	509	599	WIBX	Utica, N. Y.	100	1200	250
WBAK	Harrisburg, Pa.	1kw	1430	209.8						WICC	Bridgeport, Conn.	250	600	500
WBAL	Baltimore, Md.	10kw	1060	283	WEEU	Reading, Pa.	1kw	830	361		T-Bridgeport	500-LS		
	T-Pikeville, Md.				WEHC	Charlottesville, Va.	500	1350	222.2	WIL	St. Louis, Mo.	100	1200	250
WBAP	Fort Worth, Tex.	50kw	800	375	WEHS	Cicero, Ill.	100	1420	211.3	WILL	Urbana, Ill.	250	890	337
	T-Grapevine				WELL	Battle Creek, Mich.	50	1420	211.3	WILM	Wilmington, Del.	100	1420	211.3
WBAX	Wilkes-Barre, Pa.	100	1210	247.9	WENC	Americus, Ga.	100	1420	211.3		T-Edge Moor			
	T-Plains Twp.				WENR	Chicago, Ill.	50kw	870	345	WIND	Gary, Ind.	1kw	560	536
WBBL	Richmond, Va.	100	1210	247.9						WINS	New York, N. Y.	500	1180	254.2
WBBM	Chicago, Ill.	25kw	770	390	WESG	Elmira, N. Y.	1kw	1040	288.5		T-Carlstadt, N. J.			
	T-Glenview				WEVD	T-Ithaca				WIOD	Miami, Fla.	1kw	1300	230.8
WBBR	Brooklyn, N. Y.	1kw	1300	230.8						WMBF	T-Miami Beach			
	T-Rossville				WEW	New York, N. Y.	500	1300	230.8	WIP	Philadelphia, Pa.	500	610	492
WBBX	New Orleans, La.	100	1200	250	WEW	St. Louis, Mo.	1kw	760	395	WIS	Columbia, S. C.	500	1010	297
WBBZ	Ponca City, Okla.	100	1200	250	WEXL	Royal Oak, Mich.	50	1310	229	WISN	Milwaukee, Wis.	250	1120	267.9
WBCM	Bay City, Mich.	500	1410	212.8	WFAA	Dallas, Tex.	50kw	800	375	WJAC	Johnstown, Pa.	100	1310	229
	T-Hampton Twp.				WFAB	T-Grapevine				WJAG	Norfolk, Nehr.	1kw	1060	283
WBen	Buffalo, N. Y.	1kw	900	333						WJAR	Providence, R. I.	250	890	337
	T-Martinsville				WFAM	New York, N. Y.	1kw	1300	230.8	WJAS	Pittsburgh, Pa.	1kw	1290	232.6
WBEO	Marquette, Mich.	100	1310	229							T-No. Fayette Twp.	2 1/2 kw-LS		
WBHS	Huntsville, Ala.	100	1200	250	WFAS	White Plains, N. Y.	100	1210	247.9	WJAX	Jacksonville, Fla.	1kw	900	333
WBIG	Greensboro, N. C.	500	1440	208.3	WFBC	Greenville, S. C.	100	1200	250	WJAY	Cleveland, Ohio	500	610	492
					WFBE	Cincinnati, Ohio	100	1200	250	WJBC	La Salle, Ill.	100	1200	250
WBNX	New York, N. Y.	250	1350	222.2	WFBG	Altoona, Pa.	100	1310	229	WJBI	Red Bank, N. J.	100	1210	247.9
WBOQ	(See WABC-WBOQ)				WFBL	Syracuse, N. Y.	1kw	1360	220.6	WJBK	Detroit, Mich.	50	1370	219
WBOW	Terre Haute, Ind.	100	1310	229							T-Highland Park			
WBRC	Birmingham, Ala.	500	930	323	WFBM	Birmingham, Ind.	1kw	1230	243.9	WJBL	Decatur, Ill.	100	1200	250
WBRE	Wilkes-Barre, Pa.	100	1310	229	WFRB	Baltimore, Md.	500	1270	236.2	WJBO	New Orleans, La.	100	1420	211.3
WBSD	Needham, Mass.	500	920	326	WFDF	Flint, Mich.	100	1310	229		C.P. Baton Rouge			
WBT	Charlotte, N. C.	25kw	1080	277.8	WFDV	Rome, Ga.	100	1500	200	WJBW	New Orleans, La.	100	1200	250
WBTM	Danville, Va.	100	1370	219	WFEA	Manchester, N. H.	500	1430	209.8	WJBY	Gadsden, Ala.	100	1210	247.9
WBZ	Boston, Mass.	25kw	900	303	WFI	Philadelphia, Pa.	500	560	536	WJDX	Jackson, Miss.	1kw	1270	236.2
	T-Millis Twp.				WFIW	Hopkinsville, Ky.	1kw	940	319	WJEJ	Hagerstown, Md.	100	1210	247.9
WBZA	Boston, Mass.	1kw	900	303	WFLA	Clearwater, Fla.	250	620	484	WJEM	Tupelo, Miss.	500	990	303
	T-East Springfield				WSUN					WJJD	Mooseheart, Ill.	120kw	1130	265.5
WCAC	Storrs, Conn.	250	600	500	WFQD	Anchorage, Alaska	600	600	500	WJMS	Ironwood, Mich.	100	1420	211.3
WCAD	Canton, N. Y.	500	1220	245.9	WGal	Lancaster, Pa.	100	1310	229	WJR	Detroit, Mich.	10kw	750	400
WCAE	Pittsburgh, Pa.	1kw	1220	245.9	WGAR	Cleveland, Ohio	500	1450	206.9		T-Sylvan Lake Village			
WCAH	Columbus, Ohio	500	1430	209.8						WJSV	Alexandria, Va.	10kw	1460	205.5
WCAL	Northfield, Minn.	1kw	1250	240	WGBB	Freeport, N. Y.	100	1210	247.9	WJTL	Oglethorpe Univ., Ga.	100	1370	219
WCAM	Camden, N. J.	500	1280	234.4	WGBF	Evansville, Ind.	500	630	476		T-Atlanta			
WCAO	Baltimore, Md.	250	600	500	WGBI	Seranton, Pa.	250	880	341	WJW	Akron, Ohio	100	1210	247.9
WCAP	Asbury Park, N. J.	500	1280	234.4	WGCM	Mississippi City, Miss.	100	1210	247.9	WJZ	New York, N. Y.	50kw	760	395
	T-Whitesville				WGCP	Newark, N. J.	250	1250	240		T-Bound Brook, N. J.			
WCAT	Rapid City, S. D.	100	1200	250	WGES	Chicago, Ill.	500	1360	220.6	WKAQ	San Juan, P. R.	1kw	1240	241.9
WCAU	Philadelphia, Pa.	50kw	1170	256.4	WGH	Newport News, Va.	100	1310	229	WKAR	E. Lansing, Mich.	1kw	1040	288.5
	T-Newton, Square Co.				WGL	Ft. Wayne, Ind.	100	1370	219	WKBB	Joliet, Ill.	100	1310	229
WCAX	Burlington, Vt.	100	1200	250	WGLC	Hudson Falls, N. Y.	100	1370	219		C.P. E. Dubuque	C.P. 1500		
WCAZ	Carthage, Ill.	50	1070	280.4	WGN	Chicago, Ill.	25kw	720	417	WKBC	Birmingham, Ala.	100	1310	229
WCBA	Allentown, Pa.	250	1440	208.3	WGNy	Chester Twp., N. Y.	50	1210	247.9	WKBF	Indianapolis, Ind.	500	1400	214.3
WCBD	Zion, Ill.	5kw	1080	277.8	WGR	Buffalo, N. Y.	1kw	550	545		T-Nr. Indianapolis			
WCBS	Baltimore, Md.	100	1370	219	WGST	T-Amherst Twp.				WKBH	La Crosse, Wis.	1kw	1380	217.4
WCCO	Springfield, Ill.	100	1210	247.9	WGY	Atlanta, Ga.	250	890	337	WKBI	Cicero, Ill.	100	1420	211.3
WCCO	Minneapolis, Minn.	50kw	810	370						WKBN	Youngstown, Ohio	500	570	526
	T-Anoka				WHA	Schenectady, N. Y.	50kw	790	380	WKBV	Connersville, Ind.	100	1500	200
WCDA	New York, N. Y.	250	1350	222.2						WKBW	Buffalo, N. Y.	5kw	1480	202.7
	T-Cliffside, N. J.				WHAD	Madison, Wis.	1kw	940	319		T-Amberst Twp.			
WCFL	Chicago, Ill.	1 1/2 kw	970	309	WHAM	Milwaukee, Wis.	250	1120	267.9	WKBZ	Ludington, Mich.	100	1500	200
										WKEU	La Grange, Ga.	100	1500	200
WCKY	Covington, Ky.	5kw	1490	201.3	WHAS	Rochester, N. Y.	5kw	1150	260.9	WKFI	Greenview, Miss.	100	1210	247.9
	T-Crescent Springs									WKJC	Lancaster, Pa.	100	1200	200
WCLO	Janesville, Wis.	100	1200	250	WHAT	T-Victor Twp.	C.P. 25kw	820	366	WKOK	Lewisburg, Pa.	100	1210	247.9
WCLS	Joliet, Ill.	100	1310	229	WHAS	Louisville, Ky.	25kw	820	366	WKRC	Cincinnati, Ohio	500	550	545
WCOC	Pensacola, Fla.	500	1340	223.9	WHB	Philadelphia, Pa.	100	1310	229	WKY	Oklahoma City, Okla.	1kw	900	333
WCOC	Meridian, Miss.	500	880	341	WHBZ	Troy, N. Y.	500	1300	230.8	WKZO	Kalamazoo, Mich.	1kw	590	509
WCOD	Harrisburg, Pa.	100	1200	250	WHBC	Kansas City, Mo.	500	860	349	WLAC	Nashville, Tenn.	5kw	1470	204.1
WCRW	Chicago, Ill.	100	1210	247.9	WHBD	T-North Kansas City				WLAP	Louisville, Ky.	100	1200	250
WCSC	Charleston, S. C.	500	1360	220.6	WHBF	Canton, Ohio	10	1200	250	WLB	Minneapolis, Minn.	1kw	1250	240
WCSH	Portland, Me.	1kw	940	319	WHBL	Mt. Orab, Ohio	100	1370	219		T-St. Paul			
	T-Scarboro				WHBQ	Rock Island, Ill.	100	1210	247.9	WLBK	Muncie, Ind.	50	1310	229
WDAE	Tampa, Fla.	1kw	1220	245.9	WHBU	Sheboygan, Wis.	500	1410	212.8	WLBK	Kansas City, Kans.	100	1420	211.3
WDAF	Kansas City, Mo.	1kw	610	492	WHBY	Memphis, Tenn.	100	1370	219	WLBL	Stevens Point, Wis.	2 1/2 kw	900	333
WDAG	Amarillo, Tex.	1kw	1410	212.8							T-Nr. Ellis			
WDAH	El Paso, Tex.	100	1310	229	WHDF	Green Bay, Wis.	100	1200	250	WLBW	Erie, Pa.	500	1260	238.1
WDAS	Philadelphia, Pa.	100	1370	219	WHDH	T-West De Pere					T-Summit Township	1kw-LS		
WDAY	Fargo, N. D.	1kw	940	319	WHDL	Calumet, Mich.	100	1370	219	WLCI	Bangor, Me.	500	620	484
	T-West Fargo				WHDL	Boston, Mass.	1kw	830	361	WLEU	Ithaca, N. Y.	50	1210	247.9
WDBJ	Roanoke, Va.	250	930	323	WHDL	Tupper Lake, N. Y.	100	1420	211.3	WLEY	Erie, Pa.			

Call Letters	Location	Power (watts)	Freq (kc.)	Wave-length (meters)	Call Letters	Location	Power (watts)	Freq (kc.)	Wave-length (meters)	Call Letters	Location	Power (watts)	Freq (kc.)	Wave-length (meters)
WLWL	New York, N. Y.	5kw	1100	272.7	WOPI	Bristol, Tenn.	100	1500	200	WSAI	Cincinnati, Ohio	500	1330	225.6
WMAZ	T-Kearny, N. J.				WOQ	Kansas City, Mo.	1kw	1300	230.8	WSAJ	T-Mason	1kw-LS		
WMAL	(See WSYR-WMAC)				WOR	Newark, N. J.	5kw	710	423	WSAN	Grove City, Pa.	100	1310	229
WMAQ	Washington, D. C.	250	630	476	WORC	T-Kearny	C.P. 50kw			WSAR	Allentown, Pa.	250	1440	208.3
WMAS	Chicago, Ill.	5kw	670	448	WORK	Worcester, Mass.	100	1200	250	WSAZ	Fall River, Mass.	250	1450	206.9
WMAZ	T-Addison				WOS	T-Auburn				WSB	Huntington, W. Va.	500	580	517
WMBC	Springfield, Mass.	100	1420	211.3	WOVA	York, Pa.	1kw	1000	300	WSB	Atlanta, Ga.	5kw	740	405
WMBD	Macon, Ga.	500	1180	254.2	WOW	T-W. Manchester				WSBC	Chicago, Ill.	100	1210	247.9
WMBF	Detroit, Mich.	100	1420	211.3	WOWO	Jefferson City, Mo.	500	630	476	WSBT	South Bend, Ind.	500	1230	243.9
WMBG	Peoria, Ill.	500	1440	208.3	WPA	New York, N. Y.	1kw	1130	265.5	WSEN	Columbus, Ohio	100	1210	247.9
WMBH	T-Peoria Heights	1kw-LS			WPA	T-Secaucus, N. J.				WSFA	Montgomery, Ala.	500	1410	212.8
WMBI	(See WIOD-WMBF)				WPA	Omaha, Neb.	1kw	500	509	WSIX	Springfield, Tenn.	100	1210	247.9
WMBO	Richmond, Va.	100	1210	247.9	WPA	Pt. Wayne, Ind.	10kw	1160	258.6	WSJS	Winston-Salem, N. C.	100	1310	229
WMBQ	Joplin, Mo.	100	1420	211.3	WPA	Paducah, Ky.	100	1420	211.3	WSM	Nashville, Tenn.	50kw	650	462
WMBR	Chicago, Ill.	5kw	1080	277.8	WPA	(See WQAO-WPAP)				WSMB	T-Franklin			
WMC	T-Addison				WPCH	New York, N. Y.	500	570	526	WSMC	New Orleans, La.	500	1320	227.3
WMCA	Auburn, N. Y.	100	1310	229	WPEN	T-Flushing				WSOC	Dayton, Ohio	200	1380	217.4
WMED	Brooklyn, N. Y.	100	1500	200	WPF	Philadelphia, Pa.	100	1500	200	WSPA	Gastonia, N. C.	100	1210	247.9
WMIL	Tampa, Fla.	100	1370	219	WPG	Hattiesburg, Miss.	100	1370	219	WSPD	Spartanburg, S. C.	100	1420	211.3
WMMN	Memphis, Tenn.	500	780	385	WPHR	Atlantic City, N. J.	5kw	1100	272.7	WSUI	Toledo, Ohio	1kw	1340	223.9
WMP	T-Bartlett	1kw-LS			WPRO	Petersburg, Va.	100	1200	250	WSUN	Iowa City, Iowa	500	880	341
WMSG	New York, N. Y.	500	570	526	WPTF	T-Ettrick				WSUN	(See WFLA-WSUN)			
WMT	T-Flushing				WQAM	Providence, R. I.	100	1210	247.9	WSVS	Buffalo, N. Y.	50	1370	219
WMT	Florence, Ala.	100	1420	211.3	WQAN	T-Providence				WSYB	Rutland, Vt.	100	1500	200
WNAC	Brooklyn, N. Y.	100	1500	200	WQAP	Raleigh, N. C.	1kw	680	441	WSYR	Syracuse, N. Y.	250	570	526
WNAD	Fairmont, W. Va.	250	800	337	WQBC	Miami, Fla.	1kw	560	536	WMAC	Quincy, Ill.	500	1440	208.3
WNAX	Lapeer, Mich.	100	1500	200	WQDM	Seranton, Pa.	250	880	341	WTAD	Worcester, Mass.	500-LS	580	517
WNBY	New York, N. Y.	250	1350	222.2	WQDX	New York, N. Y.	250	1010	297	WTAG	Cleveland, Ohio	50kw	1070	280.4
WNB	Waterloo, Iowa	500	600	500	WRAC	T-Cliffside, N. J.				WTAM	T-Brockville Village			
WNB	Boston, Mass.	1kw	1230	243.9	WRBL	Vicksburg, Miss.	500	1360	220.6	WTAR	Fan Claire, Wis.	1kw	1330	225.6
WNB	T-Quincy				WRBX	St. Albans, Vt.	100	1370	219	WTAT	T-Twp. of Washington			
WNB	Norman, Okla.	500	1010	297	WRD	Thomasville, Ga.	100	1210	247.9	WTAX	Norfolk, Va.	500	780	385
WNB	Yankton, S. D.	2 1/2 kw-LS	570	526	WRD	Williamsport, Pa.	100	1370	219	WTB	College Station, Tex.	500	1120	267.9
WNB	Binghamton, N. Y.	100	1500	200	WRD	Wilmington, N. C.	100	1370	219	WTB	Springfield, Ill.	100	1210	247.9
WNB	New Bedford, Mass.	100	1310	229	WRD	Reading, Pa.	100	1310	229	WTB	Cumberland, Md.	100	1420	211.3
WNB	T-Fairhaven	250-LS			WRD	Philadelphia, Pa.	250	1020	294.1	WTB	Philadelphia, Pa.	100	1310	229
WNB	Silverhaven, Pa.	100	1200	250	WRD	Columbus, Ga.	100	1200	250	WTB	Athens, Ga.	500	1450	206.9
WNB	Memphis, Tenn.	500	1430	209.8	WRD	Roanoke, Va.	250	1110	212.8	WTB	Hartford, Conn.	50kw	1060	283
WNB	Carbondale, Pa.	10	1200	250	WRD	Augusta, Me.	100	1370	219	WTB	T-Avon			
WNB	Springfield, Vt.	250	1260	238.1	WRD	Augusta, Ga.	100	1500	200	WTB	Jackson, Tenn.	100	1310	229
WNB	Saranac Lake, N. Y.	50	1290	232.6	WRD	Memphis, Tenn.	500	600	500	WTB	Milwaukee, Wis.	1kw	620	484
WNB	Knoxville, Tenn.	2kw-LS	560	536	WRD	T-Whitehaven	1kw-LS			WTB	T-Waukesha	2 1/2 kw-LS		
WNB	New York, N. Y.	500	810	370	WRD	Lawrence, Kans.	1kw	1220	245.9	WTB	Trenton, N. J.	500	1280	234.4
WNB	San Antonio, Tex.	50kw	1190	252.1	WRD	T-Tonganoxie				WTB	Savannah, Ga.	500	1260	238.1
WNB	T-Selma				WRD	Minneapolis, Minn.	1kw	1250	240	WTB	Elkhart, Ind.	100-LS	1310	229
WNB	Charleston, W. Va.	250	580	517	WRD	T-Fridley				WTB	Hammond, Ind.	100	1200	250
WNB	Mitchellville, Iowa	50kw	1000	300	WRD	Racine, Wis.	100	1370	219	WTB	Detroit, Mich.	1kw	920	326
WNB	Jamestown, N. Y.	50	1210	247.9	WRD	New York, N. Y.	250	1010	297	WTB	New Orleans, La.	10kw	850	353
WNB	Paterson, N. J.	1kw	1250	240	WRD	T-Coytesville, N. J.				WTB	T-Kenner			
WNB	Mobile, Ala.	500	1410	212.8	WRD	Knoxville, Tenn.	100	1310	229	WTB	Asheville, N. C.	1kw	570	526
WNB	T-Springhill				WRD	Dallas, Tex.	500	1280	234.4	WTB	Woodside, N. C.	100	1500	200
WNB	Ames, Iowa	5kw	640	469	WRD	Gainesville, Fla.	5kw	830	361	WTB	Pittsburgh, Pa.	100	1500	200
WNB	Albany, N. Y.	500	1440	208.3	WRD	Richmond, Va.	5kw	1110	270.3	WTB	T-Wilkinsburg	250-LS		
WNB	Washington, D. C.	100	1310	229	WRD	T-Mechanicsville				WTB	Wheeling, W. Va.	5kw	1160	258.6
WNB	Manitowoc, Wis.	100	1210	247.9	WRD					WTB	Detroit, Mich.	1kw	1240	241.9
WNB	Grand Rapids, Mich.	500	1270	236.2	WRD					WTB				

## POLICE STATIONS (Alphabetically by Call Letters)

Call Letters	Location	Freq. (kc.)	Call Letters	Location	Freq. (kc.)	Call Letters	Location	Freq. (kc.)	Call Letters	Location	Freq. (kc.)
KGHO	Des Moines, Iowa	1534	KGZI	Wichita Falls, Tex.	1712	WPDH	Richmond, Ind.	2442	WPES	Saginaw, Mich.	2442
KGJX	Pasadena, Calif.	1712	KGZJ	Phoenix, Ariz.	2430	WPDI	Columbus, Ohio	2430	WPET	Lexington, Mass.	1712
KGOK	Cedar Rapids, Iowa	2470	KGZL	Shreveport, La.	1712	WPDJ	Passaic, N. J.	2416	WPEW	Northampton, Mass.	1574
KGPA	Seattle, Wash.	2414	KGZM	El Paso, Tex.	2414	WPDK	Milwaukee, Wis.	2450	WPEY	Chattanooga, Tenn.	2470
KGPB	Minneapolis, Minn.	2416	KGZN	Tacoma, Wash.	2414	WPDL	Lansing, Mich.	2442	WPEZ	Framingham, Mass.	1574
KGPC	St. Louis, Mo.	1712	KGZO	Santa Barbara, Calif.	2414	WPDM	Dayton, Ohio	2430	WFFA	Newton, Mass.	1712
KGPD	San Francisco, Calif.	2470	KGZP	Coffeyville, Kans.	2450	WPDN	Auburn, N. Y.	2458	WFFC	Muskegon, Mich.	2442
KGPE	Kansas City, Mo.	2422	KGZQ	Waco, Tex.	1712	WPDO	Akron, Ohio	2458	WFFD	Highland Park, Ill.	2430
KGPF	Vallejo, Calif.	2422	KGZR	Salem, Ore.	2442	WPDP	Philadelphia, Pa.	2470	WFFE	Reading, Pa.	2442
KGPG	Oklahoma City, Okla.	2450	KGZS	McAlester, Okla.	2450	WPDQ	Rochester, N. Y.	2458	WFFG	Toins River, N. J.	2430
KGPH	Omaha, Neb.	2470	KIDA	Seattle, Wash.	1574	WPDS	St. Paul, Minn.	2416	WFFH	Jacksonville, Fla.	2442
KGPI	Beaumont, Tex.	1712	KISW	Berkeley, Calif.	2422	WPDV	Kokomo, Ind.	2470	WFFI	Baltimore, Md.	2414
KGPJ	Sioux City, Ia.	2470	KJVP	Dallas, Tex.	1712	WPDW	Pittsburgh, Pa.	1712	WFFJ	Columbus, Ga.	2414
KGPK	Los Angeles, Calif.	1712	KJWA	Harrisburg, Pa.	257	WPDV	Charlotte, N. C.	2458	WFFK	Hammond, Ind.	1712
KGPL	San Jose, Calif.	2470	KJWB	Butler, Pa.	257	WPDW	Washington, D. C.	2422	WFFL	Hackensack, N. J.	2430
KGPM	Davenport, Iowa	2470	KJWC	Belle Island, Mich.	2414	WPDY	Detroit, Mich.	2414	WFFM	Gary, Ind.	2470
KGPN	Tulsa, Okla.	2450	KJWD	Wyoming, Pa.	257	WPDZ	Atlanta, Ga.	2414	WFFN	Birmingham, Ala.	2414
KGPO	Portland, Ore.	2442	KJWE	Boston, Mass.	1574	WPEA	Fort Wayne, Ind.	2470	WFFO	Fairhaven, Mass.	1712
KGPP	Honolulu, T. H.	2450	KJWF	Detroit, Mich.	1574	WPEB	Syracuse, N. Y.	2458	WFFP	Knoxville, Tenn.	2470
KGPR	Fort Worth, Tex.	1712	KJWG	Cincinnati, Ohio	1712	WPEC	Grand Rapids, Mich.	2442	WFFQ	Clarksburg, W. Va.	2414
KGPS	Bakersfield, Calif.	2414	KJWH	Reading, Pa.	257	WPEE	Memphis, Tenn.	2470	WFFR	Swathmore, Pa.	2470
KGPW	Salt Lake City, Utah	2470	KJWI	Indianapolis, Ind.	2442	WPEF	Arlington, Mass.	1712	WFFS	Johnson City, Tenn.	2470
KGQX	Denver, Colo.	2442	KJWJ	Buffalo, N. Y.	2422	WPEG	Brooklyn, N. Y.	2450	WFFT	Asheville, N. C.	2458
KGQY	Shreveport, La.	1574	KJWK	Highland Park, Mich.	2414	WPEH	New York, N. Y.	2450	WFFU	Lakeland, Fla.	2442
KGQZ	Wichita, Kans.	2450	KJWL	Framingham, Mass.	1574	WPEI	New York, N. Y.	2450	WFFV	Portland, Me.	2422
KGZA	Fresno, Calif.	2414	KJWM	Miami, Fla.	2442	WPEJ	Somerville, Mass.	1712	WFFW	Pawtucket, R. I.	2470
KGZB	Houston, Tex.	1712	KJWN	Tulare, Calif.	2414	WPEK	E. Providence, R. I.	1712	WFFX	Mt. Pleasant, N. Y.	2414
KGZC	Topeka, Kans.	2442	KJWO	Chicago, Ill.	1712	WPEL	Brookline, Mass.	1712	WFFY	Palmetto Beach, Fla.	2442
KGZD	San Diego, Calif.	2430	KJWP	Chicago, Ill.	1712	WPEM	New Orleans, La.	2422	WFFZ	Yonkers, N. Y.	2414
KGZE	San Antonio, Tex.	2506	KJWQ	Chicago, Ill.	1712	WPEP	W. Bridgewater, Mass.	1574	WRDH	Cleveland, Ohio	2458
KGZF	Chanute, Kans.	2450	KJWR	Louisville, Ky.	2442	WPEQ	Woonsocket, R. I.	2470	WRDQ	Toledo, Ohio	2470
KGZG	Des Moines, Ia.	2470	KJWS	Flint, Mich.	2442	WPEQ	Arlington, Mass.	1712	WROR	Grosse Pointe Village, Mich.	2414
KGZH	Klamath Falls, Ore.	2442	KJWT	Youngstown, Ohio	2458	WPEQ	Baton Rouge, La.	1574	WRDS	East Lansing, Mich.	1574



# THE MAINTENANCE OF CARBON MICROPHONES

Even the best of carbon microphones has a very definite and limited life, especially when subjected to the rough handling usually encountered in broadcasting and sound work. Mr. Kahn describes the best rejuvenating methods.

ALBERT R. KAHN

IT WAS not so very long ago that microphones were treated, quite respectfully and were viewed with not a little mystery even by those who used them. However, with the increasing use and demand for public address equipment the microphone has come to be considered as an ordinary piece of equipment, and handled as such, and the requirements of microphone service have become increasingly severe.

Sound trucks, with their jar and vibration cause premature aging. Wobbly speakers' platforms do their part in furthering the microphone repair industry. And the old, iron-clad rule, "never move a microphone with the current applied" is difficult to impress upon public speakers and performers.

Fortunately, for the sound engineer, the life of a microphone can be renewed by the replacement of grains, in most instances. If the instrument has had long periods of high current or been subjected to extremely hard usage, the replacement of buttons and diaphragm is necessary.

In use, the button current is applied to a double-button carbon microphone through a center-tapped microphone input transformer primary. The current flows from the buttons through the grains to the diaphragm which is at ground potential. While operating, the grains are moving constantly, being actuated by the diaphragm or by the shaking of the microphone, itself. This movement of the carbon grains causes a microscopic arc which will, in time, burn the polish from the surface. The greater the movement and the higher the current, the faster the wear. Unless the microphone has been used at high values of button current, the diaphragm and buttons will not burn in this manner but will gather a film of corrosion. All of this tends to reduce the sensitivity and output and increases the noise level. It is sometimes difficult to get sufficient current through the microphone and to get the buttons to "balance."

The method of replacing the grains depends, somewhat, upon the design of the instrument. Figure 1 illustrates the

conventional method of construction. The buttons are held in place by a front and back bridge, A and B, both of which are removed by taking out the screws holding them to the frame. The old carbon is then discarded. Taking extreme care not to injure the felt carbon-retaining rings, C and D, clean the buttons well with carbon tetrachloride, ether or chemically-pure alcohol. Use cotton or a soft cloth for this operation to insure freedom from scratching the surfaces. In the event that the felts are injured, new ones may be cut from a cheap grade of cotton batting if care is taken to get the same thickness as the original.

The diaphragm, E, next gets attention, and is cleaned in the same manner as the buttons. Care must be taken not to rub through the gold coating in some makes of diaphragms.

If the buttons are burned or have lost their polish beyond use, it is good policy to replace them with new ones. When doing this, *maintain the original distance between the button face and the diaphragm*, as this has a very definite bearing on the sensitivity and quality. The retaining felt should have no real pressure on the diaphragm but should just touch it firmly enough to prevent the grains from dropping out.

If an examination discloses that the diaphragm is burned, dented or otherwise in bad condition, this too, should be replaced. As shown in Fig. 1, the outer edge of the diaphragm is clamped by the frame. Stretching-ring G exerts a pressure on it and holds it in a stretched position. The degree of stretch depends upon the diaphragm material used. Steel, which is used in some of the lower-priced instruments needs little as the weight of this material helps to damp the movement. Duralumin needs more stretching because of the lightness and is in the order of three-quarters of its elastic limit. In other words, a diaphragm can be over-stretched and cause a reduction of the sensitivity, especially on the lower register. For one not having access to equip-

(Continued on page 305)

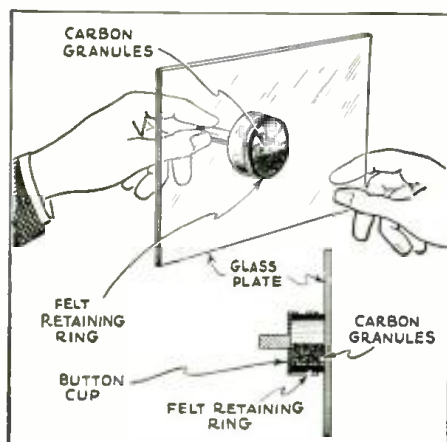

Fig. 2

The method of measuring carbon grains.

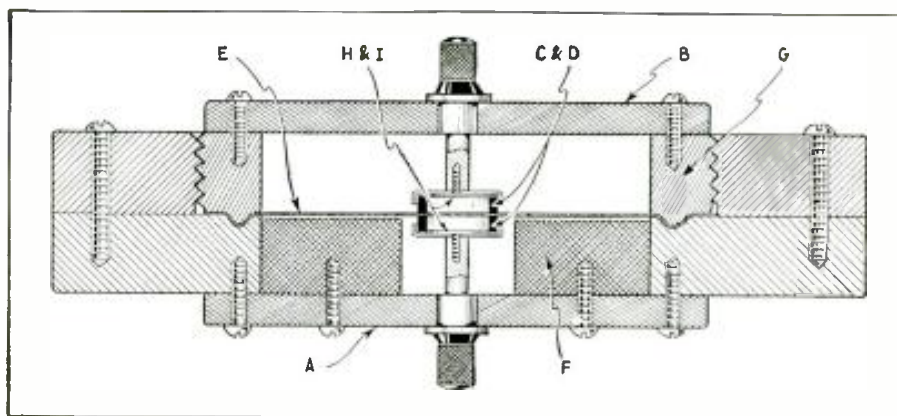

Fig. 1

A cross-section of a two-button microphone, detailing the important parts. Note that the diaphragm, E, is suspended between carbon cups H and I.

# THE ANALYSIS OF RADIO RECEIVER SYMPTOMS

## OPERATING NOTES

R. L. DOUGHERTY

### ELIMINATING AUTO-RADIO NOISES

WITH the lower pricing of automobile radio sets, and the fact that conditions are getting more prosperous throughout the country, the sale and installation of these units is taking a big jump. This is everywhere evident in the number of queries concerning this work, and the amount of noise elimination that the writer has been called upon to do. As this type of work is not new to me, but is to the majority of radio men, this article is addressed to those who "would like to know" but cannot find out.

The first time that the average radio Service Man or technician attempts to install an automobile radio set it is a case of "imagine my embarrassment" when, after the set has been nicely and firmly placed, the nice new suppressors installed, condensers wired into circuit, and possibly an under-car aerial connected that, the motor being turned on, there is a faint sound of music subdued in a "foreground" of ignition static! If he is the average Service Man, he has doubtless been queried countless hundreds of times about removing static—and here he is, after swearing that it is not possible, with the prettiest bunch of localized static in the world to remove. Oh well, that's what he gets for being a "radio master mind."

Then there is also the fact that the newer sets are so greatly advertised as being "Installed in less than three-quarters of an hour—even by a novice." Blah, and more blah! It generally takes more than two to three hours of continuous and steady work before the job is fully completed. If you don't believe that, here is a positive shop record of a professional "auto-radio" man over a period of a week.

Seventeen cars, thirteen of which were current models, one was one year old, a second two years old, and two more were three years old but of a make which "doesn't get old with the years." In these seventeen cars four different makes of radio sets were installed—Philco, RCA, Motorola and Atwater Kent. From actual shop time records with every minute of actual work accounted for (no time off for smokes or going next door to get additional parts) the average time for the seventeen sets was three hours and fifty minutes! Furthermore, as a check, fully three-quarters of that time was marked down to noise elimination. Also, take into consideration the fact that as a specialist, all the necessary equipment, wrenches, shielding and all tools necessary to a neat, speedy and efficient installation were right at hand.

#### Routine Procedure

In all cases a set routine should be followed. First and foremost the set should be placed on a bench, hooked up and

### PRIZE WINNING ARTICLE

To Mr. R. L. Dougherty of Neptune, N. J., goes the honor of winning the first prize of \$15.00 in the \$50.00 prize contest held recently by Federated Purchaser, Inc. By special arrangement with this company, we are pleased to be able to publish this article in its entirety. (For further information on the elimination of noise in automotive radio receivers, readers are referred to past issues of RADIO-CRAFT, and to the very complete book, "Automobile Radio and Servicing," by Louis Martin.—*Technical Editor*)

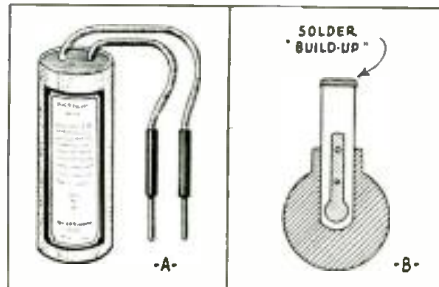

Fig. 1  
Details of car radio service.

With car sets using the "dynamotor" for furnishing the high "B" there should be no ripple at all and the sound of the motor itself should be just barely noticeable when you stand about two feet from the unit. If there is any ripple at all in the speaker when the set is tuned to the frequency of a local station—replace the unit.

#### Installing the Set

Select the location for the set, watching that you have plenty of room on all sides, and making sure that the remote cable from the steering column will reach to where you are going to place the set. After the actual installation of the set, control, eliminators or batteries and before the antenna of the set is connected, put on the suppressors, distributor and generator cutout condensers, and with the battery connected, turn on the set to allow it to warm up. Coil the antenna lead from the set around on itself to neutralize outside pickup and turn on the motor. Nothing will be heard as far as a signal goes but plenty of noise will be heard.

Have a couple of spare condensers handy. One equipped with test prods as shown in Fig. 1 is a very handy tool. If the noise sounds excessive, this shows that there is a great amount of ignition noise getting into the circuit through  
(Continued on page 308)

balanced. This is really important. Never under any consideration take a new set out of a carton and slap it into a car. Go over the set thoroughly. If it is a superheterodyne of the latest make with everything in one case, this simply means connecting a suitable storage battery, connecting the remote controls, and tuning the set. *Do not attempt to balance the set on an outside or regulation set aerial.* If the set is to be installed in a garage or place that is fairly well shielded, connect the antenna that you are going to use, and supplement it by laying on top of the antenna a length of insulated wire about thirty to fifty feet long to increase the pickup to normal. If the shop is to specialize in installation, it would be a good idea to use two plate antennas spaced about 1/2-in. apart, one being connected to a regulation aerial, and the other to the set proper. A ground is not necessary and in the shop is not used. Balance the set accurately by means of a calibrated oscillator after the fashion of a house radio set, and note the noise level of the particular set. It is the habit of a majority of the newer sets that are being built in one unit (with a vibrator-type "B" eliminator) to be very "huzzy" sometimes when first hooked up. If the set seems to be exceptionally noisy in this respect, change it. Otherwise, if there is just a slightly noticeable buzz it will wear off after breaking-in of the eliminator contact points.

# READERS' DEPARTMENT

A department in which the reader may convey his thoughts to other readers. Included in this department are letters, kinks, short cuts, and experiments. Send in your ideas.

## BRINGING THE MOUNTAIN TO MOHAMMED—1933 VERSION

Editor, RADIO-CRAFT:

In this day and age one has really to clarify his services in order to reach the consumer. This business of putting out a "shingle" and then waiting for business to overwhelm you is a thing of the past. One very good way to put a few extra dollars in your pockets is to fill up the service car with your complete equipment and start out "house-to-house."

This scheme has a number of advantages. One is that the job is done at the house and there is no more bother with sets around the shop. Of course, there will be a few which will have to be taken out. In the summer time or in warm climates all jobs can be done in the car, if you have a large truck with a regular service-panel layout. Another advantage is that you can get the business of the customer (and there are lots of them) who does not want the set taken away.

Some idea of the equipment required for this method of radio service can be had from the following list:

One service truck or car, set analyzer and oscillator; a large assortment of parts, such as, power transformers, filter and smaller condensers, resistors, volume controls, etc.; a complete set of tools; dynamic and magnetic speakers; a complete set of tubes; a small rug to spread on the floor.

I think the Service Man will find this idea will net him a little extra money and will be well worth his time.

CLARENCE E. SWINK  
421 So. Illinois Ave.  
Villa Park, Ill.

(Mr. Swink believes that the way to find out whether "prosperity" is around

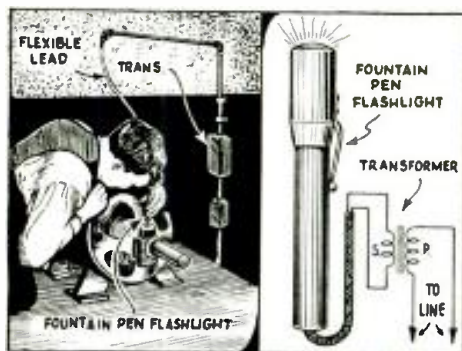

Fig. 1

A light that is handy for the service bench. An A.C. transformer supplies the spot-light current.

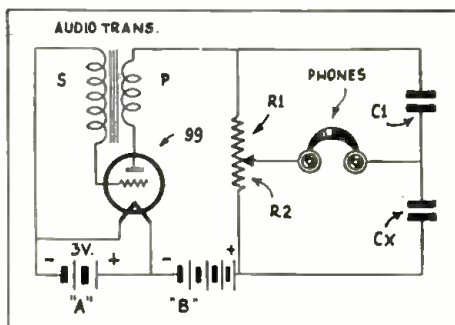

Fig. 2

A capacity bridge for condenser measurements.

the corner is to hop into a service truck, buzz around the corner, and find out. This is a good tip for the fellow with enough ambition left to try it.—Editor.)

## A RURAL COMMENT

Editor, RADIO-CRAFT:

After all, I see that there are a few Service Men left in the country districts. I was beginning to think there was A.C. or D.C. power everywhere except here, as all of the radio publications have just about quit publishing helps for those who have to stick to battery-operated sets. If it were not for RADIO-CRAFT and SHORT WAVE CRAFT, we would be "out." sure enough. *They are the two best radio magazines on the market today—I never miss a copy of either.*

Mr. Robert Rogers in his letter in the July, 1933, issue of RADIO-CRAFT expressed my feelings exactly.

Thanks to Mr. Ray L. Wonderly, also, for his suggestion about changing model 67 Atwater Kent to use 2 V. tubes. I ran up with this problem today and expect to try his suggestion.

June RADIO-CRAFT is worth many times a year's subscription price to the Ser-

vice Man who is working with automobile "radios."

ALVA H. CLARK  
Linden, N. C.

## A SMALL LIGHT FOR BIG JOBS

The peep-hole light shown in Fig. 1, is extremely valuable for searching out small parts of equipment to be repaired or inspected. It enables the repairman to thoroughly inspect the bearings, oil rings and small parts of motors and other equipment without disassembling.

Installed at the East Pittsburgh works of the Westinghouse Electric and Manufacturing Company, this inexpensive miniature spot light was constructed from an ordinary fountain pen type flashlight. It is attached to a flexible cord and arm in a convenient position over the bench and is energized with a small transformer mounted on the wall. As the ordinary extension light is rather cumbersome and cannot be used for getting into the interior parts of small apparatus this trouble light has proven itself to be a time saver and a valuable addition to the inspection bench. When not in use the light may be placed in the receptacle at the end of the arm and swung aside until needed.

## MEASURING SMALL CAPACITIES

Very often I have needed some means of measuring the capacity of a condenser. However, the usual arrangements require expensive apparatus that I do not possess. Therefore, I evolved the circuit shown in Fig. 2.

The tube and A.F. transformer form an oscillating circuit. The resistors R1 and R2 are the two parts of an ordinary wire-wound potentiometer. C1 is a

(Continued on page 315)

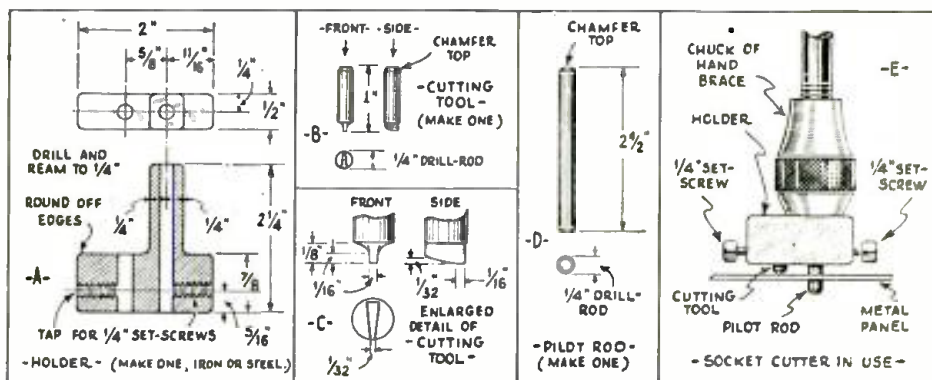

Fig. 3

Constructional details for making a "fly" cutter for drilling socket holes.

MAJESTIC CHASSIS MODEL 460 6-TUBE A.C. SUPERHETERODYNE

(The model 460 chassis is used in receiver models 461 and 463. The chassis incorporates new tube types including the G-2A7-S pentagrid converter, G-55-S duodiode-triode, and G-2A5 pentode. Also, an exceptionally selective input circuit, delayed A.V.C., line noise filter.)

The Majestic model 460 chassis is most readily recognized by the modernistic designs of the cabinets of models 461 and 463 receivers in which it is incorporated. The improved pre-selector circuit results in very high image attenuation and greater stage gain, with consequent lowered percentage of noise for a given output level.

Tube voltage characteristics are as follows:

Tube Type	Cath. Volts	S-G, Volts	Plate Volts
V1	4.2	92	260
V2*	4.2	92	260
V3	4.2	92	260
V4**	23.0	—	65
V5	15.0	260	243

\*Modulator figures are tabulated; oscillator S-G, volts, 0, and plate volts, 92.

\*\*Actual triode plate voltage. This reading will be much lower if a low-resistance voltmeter is used, due to the drop across R3. The rectified filament-to-ground potential is 340 V., D.C.; line voltage, 115 V.; volume control in maximum position.

When aligning the receiver circuits, manual volume control R1 must be in the maximum volume position. Supply a 175 kc. signal to the grid of V2 and adjust the trimming condensers in shunt to the I.F. transformers for maximum output. Finally, set the 3-gang condenser to the minimum-capacity position and supply a 1,730 kc. signal to the input of the receiver and align the trimming condensers for maximum output. After the receiver has been aligned, the sensitivity should be 10 microvolts or

less for an output signal of 100 milliwatts at 30% modulation.

Three colored dots on a mica condenser indicates its capacity and the two colored dots, its D.C. working voltage. The colors have been assigned as follows: 0, black; 1, brown; 2, red; 3, orange; 4, yellow; 5, green; 6, blue; 7, purple; 8, gray; 9, white. On condensers having three dots on one side and two on the other, the designations are to be read with the capacity rating (3 dots) at the bottom, while on condensers having all five dots on one side, the designations are to be read with the capacity rating at the top.

Referring to this code, the first color indicates the first digit of the capacity expressed in mmf. The second color indicates the second digit of the capacity, also expressed in mmf. The third color indicates the number of ciphers following the second digit of the capacity. The following examples are given: red, green and brown dots, 250 mmf.; brown, black and red dots, 1,000 mmf. Again referring to the code, the first colored dot indicates multiples of 100 V. and the second one indicates multiples of 10 V. Examples: orange and green dots, 350 V.; blue and black dots, 600 V.

We wish to call the attention of Service Men to a forward step taken by Majestic toward the development of a chassis-coding color code. Tentative specifications are as follows:

- Blue, yellow tracer—high V. from rectifier (filter input);
- Red—"B" plus;
- Orange—cathode;
- White—screen-grid;
- Blue—filament;
- Black—filament and ground;
- Green—grid return;
- Brown—cathode return;
- Black, red tracer—control-grid;
- White, red tracer—control-grid (condenser);
- Orange, black tracer—suppressor-grid;
- Black, yellow tracer—special plate;
- Blue, red tracer—special screen;
- Yellow—all plates;
- White R.C.—A.V.C. circuits;
- Yellow R.C.—special A.V.C. circuits;
- Black and red twisted—pilot lamp.

(For some time to come there will be cases where substitutes will be made for the purpose of using up inventory. There may also be cases which arise where it will be impossible to obtain the specific wire when needed, in which case a substitute will be made. In general, however, the above code will be strictly adhered to.)

model 460 chassis follows the modern trend of having an improved over-load and A.V.C. action, but without the customary disadvantages of the more conventional circuits. This is accomplished by utilizing one diode plate of V4 for A.F. development only, and the other for A.V.C. voltage only. It is, therefore, possible to design an A.F. circuit and an A.V.C. circuit of optimum constants without any sacrifice of tone to aid the other as has been the case in previous receivers. The result of this design is a much greater power output for very weak, as well as strong, signals and a very constant output level over an extremely wide range of signal inputs, which effectively overcomes fading. The speaker field measures 1,070 ohms.

The G-2A7-S pentagrid converter tube, V2, is used for two definite reasons. First, it gives a very flat sensitivity over the band covered and, second, it makes it possible to control this stage with the A.V.C. voltage.

The G-2A5 pentode is capable of giving a large power output with a relatively small input signal voltage. The power handling ability of V5 is essentially the same as that of the G-59 with pentode connection.

The letter S as the last letter on Majestic tube type numbers indicates that the tube is spray-shielded. This shield is grounded to the cathode, as shown in the schematic circuits.

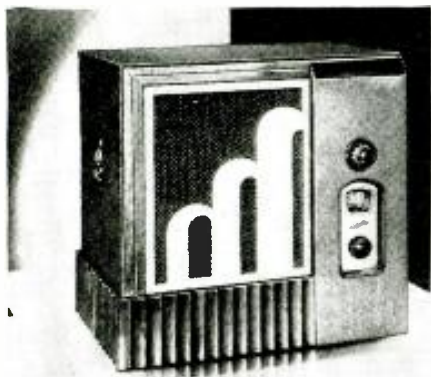

The modernistic model 463 receiver

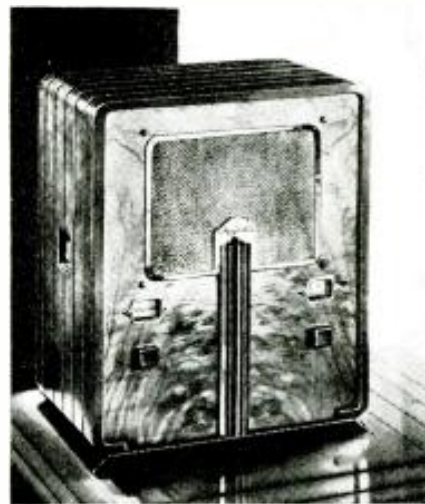

The new model 461 superheterodyne.

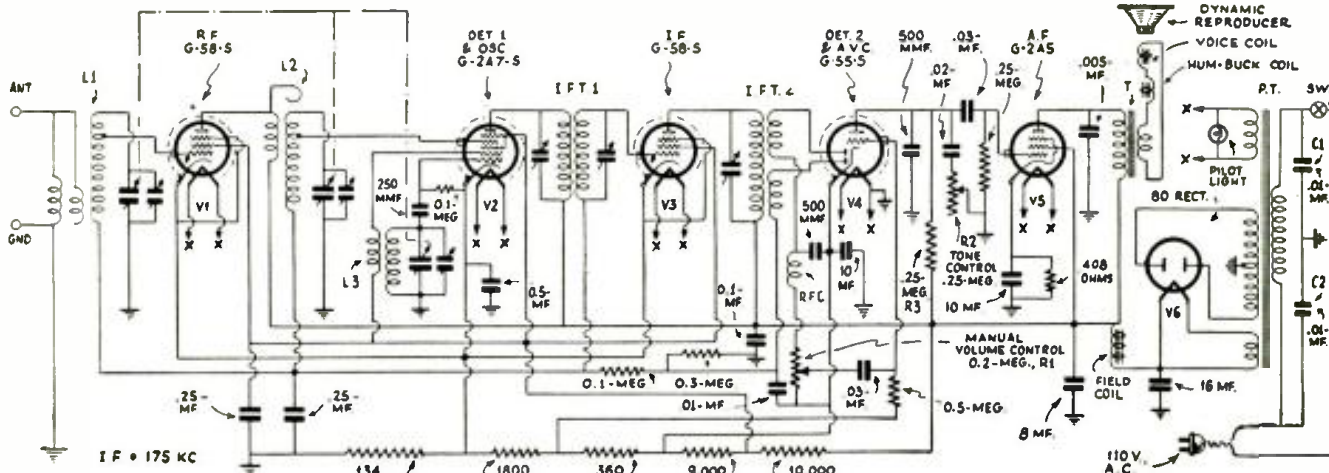

COLONIAL MODELS 250, 279, AND 300 5-TUBE A.C.-D.C. SUPERHETERODYNES

(Two chassis, types 128A and 128B, cover these three receivers. The following features are incorporated in both chassis: a voltage-doubler rectifier connection; uses types 6A7 and 6B7 tubes as oscillator and first-detector, and I.F. and A.V.C., respectively; A.V.C.)

Numerous features in the Colonial models 250, 279, and 300 illustrated; the case is molded bakelite receivers, make the technical data concerning them of exceptional interest to the Service Man.

An A.C.-D.C. switch, Sw. 1, controls the circuit for best operation under the conditions of power line voltage plate supply in the D.C. position, and the increased voltage obtained from a "voltage doubler" circuit in the A.C. position. Because the 6A7 tube is used as a combination oscillator and first detector, and the 6B7 as an A.V.C. and I.F. amplifier, the receiver is equivalent to a set using seven tubes. The R.F. coils are special, litz-wound units having an exceptionally high Q factor and low R. The dial is calibrated in kc. The power cord incorporates resistor R6. The reproducer field coil also functions as the only choke coil in the filter system. Tube operating voltage and current characteristics are given below. The field coil potential is 70 V. Measurements were made with a 500 V., high-resistance meter; line voltage, 118 V., A.C.; set detuned, and speaker field "hot." Care should be used when taking readings with a set analyzer as the capacity of the cables may cause circuits to oscillate, resulting in erratic readings. (Usually, touching the grid or plate will stop oscillation.)

Tube	C.G.	S.G.	Plate	S.G.	Plate
Type	Volts	Volts	Volts	Ma.	Ma.
V1	7*	55	110	0.2	0.4
V2	-1.5	22	50	.04	0.1
V3	-10*	120	100	5.0	26
V4	—	—	—	—	2
V5**	—	—	—	—	40

\*Indicates high resistance.



\*\*Grid No. 1, 5 V.; No. 2, 105V.; Nos. 3 and 5, 55 V.; No. 4, 1 V. Current figures: grid No. 2, 1.3 ma.; Nos. 3 and 5, 1.2 ma.

The negative voltage drop across R2 and R3 is applied to the control-grid of V1; the negative voltage drop across R3 is applied to the control-grid of V2. Residual bias for V1 is furnished by R5; and for V2, by R4.

The A.V.C. action can be rendered inoperative when peaking the I.F. transformers by unsoldering one side of C, which is mounted across the socket of V2. Trimmers C1 to C4 are accessible from the front of the chassis.

Receivers which are rubber stamped 128A

on the chassis are wired as shown in the indicated circuit below; "B" chassis are wired as per the other diagram, below.

All metal parts of the chassis, including Sw. 1, are at high potential to ground. Therefore, do not ground the chassis; also, do not touch the chassis while the power cord is plugged into the power outlet.

The loud-speaker may be removed for replacement by taking off the V2 tube shield and removing the three speaker mounting screws. Be certain that the speaker leads color code is followed. Incorrect connection of the leads will cause the hum voltage in the hum-buck coil to cause an increase in the audio hum level instead of cancelling it.

Referring to the diagram of chassis 128A it will be noted that in the A.C. position of Sw. 1, the rectifier filament and cathode A2 differ in voltage by the maximum voltage output of the voltage doubler circuit. This condition has been corrected in the circuit shown for chassis 128B, where the maximum potential difference between the filament and the maximum-voltage cathode has been reduced to the line potential.

In both circuits, first-section plate A1 and condenser C5 are inoperative in the D.C. position of switch Sw. 1. However, the second section, B1, B2, of rectifier V5 has been rewired so that instead of passing the total current required by the set (including the current for the field coil) with the rectifier section in the negative leg of the high-voltage circuit (as shown in the circuit of chassis 128A) it is in the positive leg, as shown in the circuit of chassis 128B. (Instantaneous polarities of the power line are shown in parentheses.)

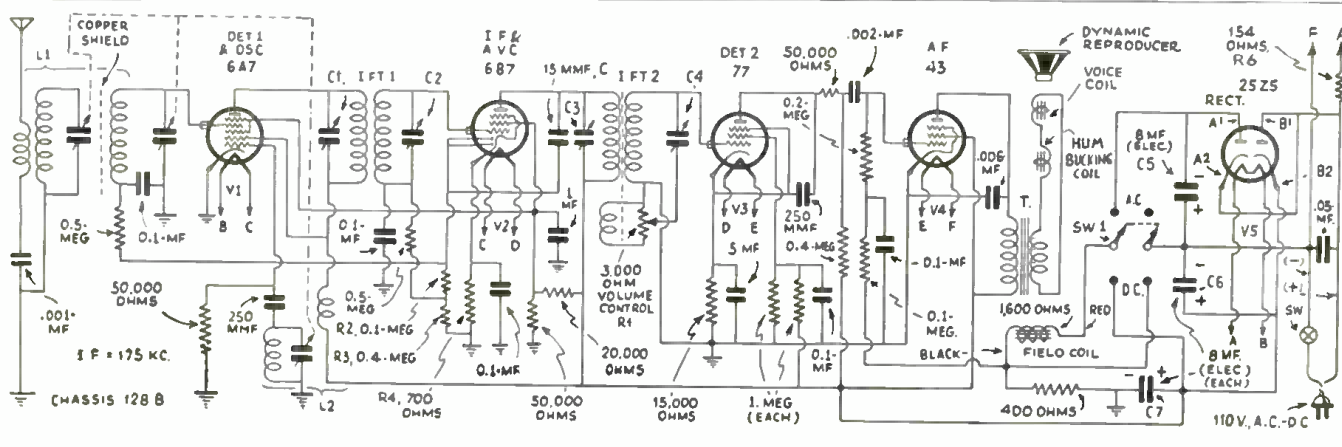
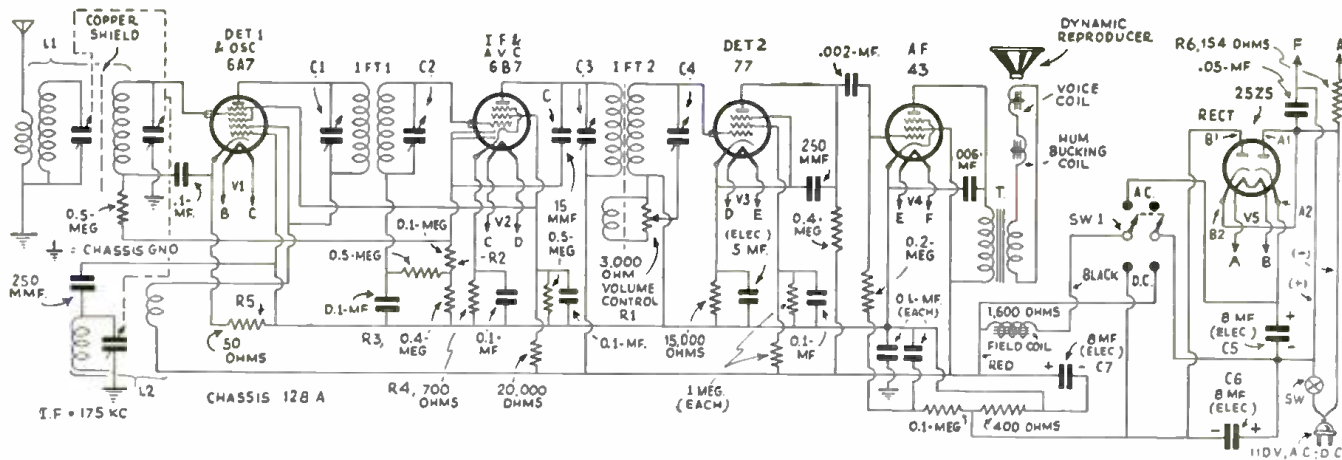

# THE BEGINNER'S "UNIT CHASSIS" CRYSTAL AND 2-TUBE RADIO SET

Previous "Beginner's" articles in RADIO-CRAFT have been devoted almost exclusively to the design of "bread-board" radio receivers. In the following article the author discusses further the "chassis-type" design which more closely follows standard radio set construction. One more tube has been added to the chassis described last month.

## PART II

FRANCIS R. HARRIS

CHASSIS construction is universally used in modern radio apparatus for a number of very good reasons. In the first place shielding is necessary in any receiver with more than one stage of R.F. amplification, especially with modern high-gain tubes. This shielding, to be effective, must be thick, at least one-sixteenth inch; material of this thickness has considerable mechanical strength, hence its use as a base on which to mount all the apparatus. Furthermore, chassis construction allows of placing units which are wired together one over the other and makes possible a compact construction while at the same time sacrificing nothing electrically, in fact in many cases a distinct gain is secured through the use of short, direct leads. In other words, chassis construction is lighter, stronger, electrically superior, more compact and gives a more workmanlike appearance to the job on which it is used.

In spite of these obvious advantages it is very seldom that one finds a beginner in radio work using this type of construction; probably because he has the mistaken idea that it is expensive and difficult—mistaken because, while both thoughts are true to a certain extent, expense and difficulty can both be minimized by proper design such as has been employed in laying out the beginner's chassis described below and in last month's issue.

Some years ago there was available on the open market a unit chassis so constructed that a large number of experimental circuits could be wired up without changing the mechanical layout. Somewhat the same idea has been followed in laying out this series.

The chassis described last month, for instance, is used (with only slight changes in the wiring) again this time

with the addition of a second unit practically identical; the schematic circuit is Fig. 1. These chassis, and others like them, will be used in future layouts for all kinds of circuits. Expense, therefore, due to the fact that the same material is used over and over again, will be very slight.

As for difficulty, that is largely a matter of getting used to the idea of working metals and of getting the "feel" of handling them. Most of us have worked with wood a great deal, we had manual training in grade school, it is a familiar

(Continued on page 312)

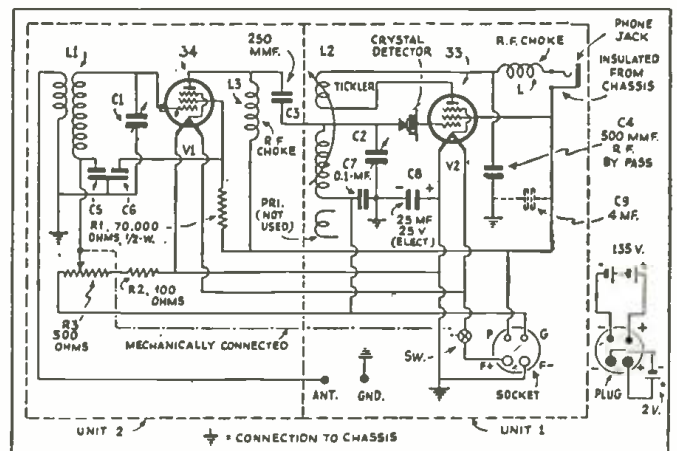

Fig. 1  
Schematic circuit of the crystal and 2-tube receiver.

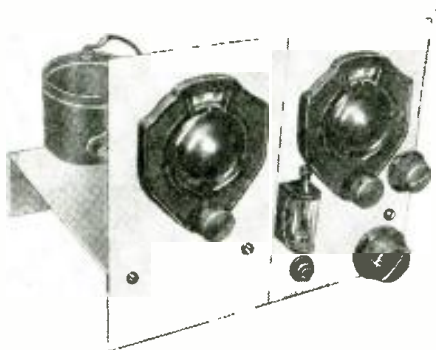

Fig. A  
The front view of the receiver showing the two panels blocked together as a complete unit. The beginner's "unit chassis" crystal and 1-tube radio set described in the preceding issue of RADIO-CRAFT is the panel shown at the extreme right.

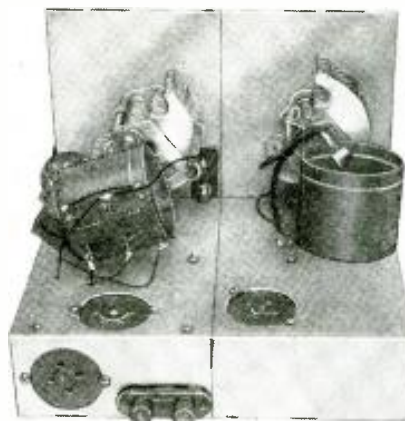

Fig. B  
The rear view of the two chassis.

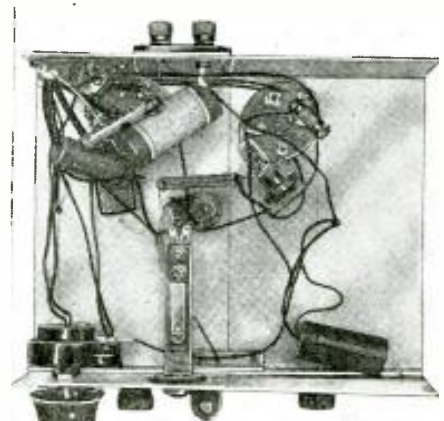

Fig. C  
The underside view, disclosing the wiring.

# The Best **NEWS** of the Year

Your Copy

is Ready!

Every man connected in any way with the booming auto-radio business will want a copy of this book immediately. It is devoted exclusively to auto-radio service "dope," in complete, understandable form. The OFFICIAL AUTO-RADIO SERVICE MANUAL contains schematic diagrams, chassis layouts, mounting instructions, and trouble-shooting hints on all 1933 and many older model auto-radio receivers. This Manual contains a "gold-mine" of information.

Over 200 Pages

Over 500 Illustrations

9x12 Inches

Flexible, Loose-Leaf Cover



Order Your Copy Today!

You have the opportunity to get your copy of the 1933 OFFICIAL AUTO-RADIO SERVICE MANUAL from the first printing of which we have copies on hand. The Auto-Radio Service Manuals are selling so quickly that already another print order has been authorized. We urge you to get your copy now so that it will not be necessary for you to be without a copy of this manual.

**GERNSBACK PUBLICATIONS, Inc.**

96-98 Park Place

New York, N. Y.

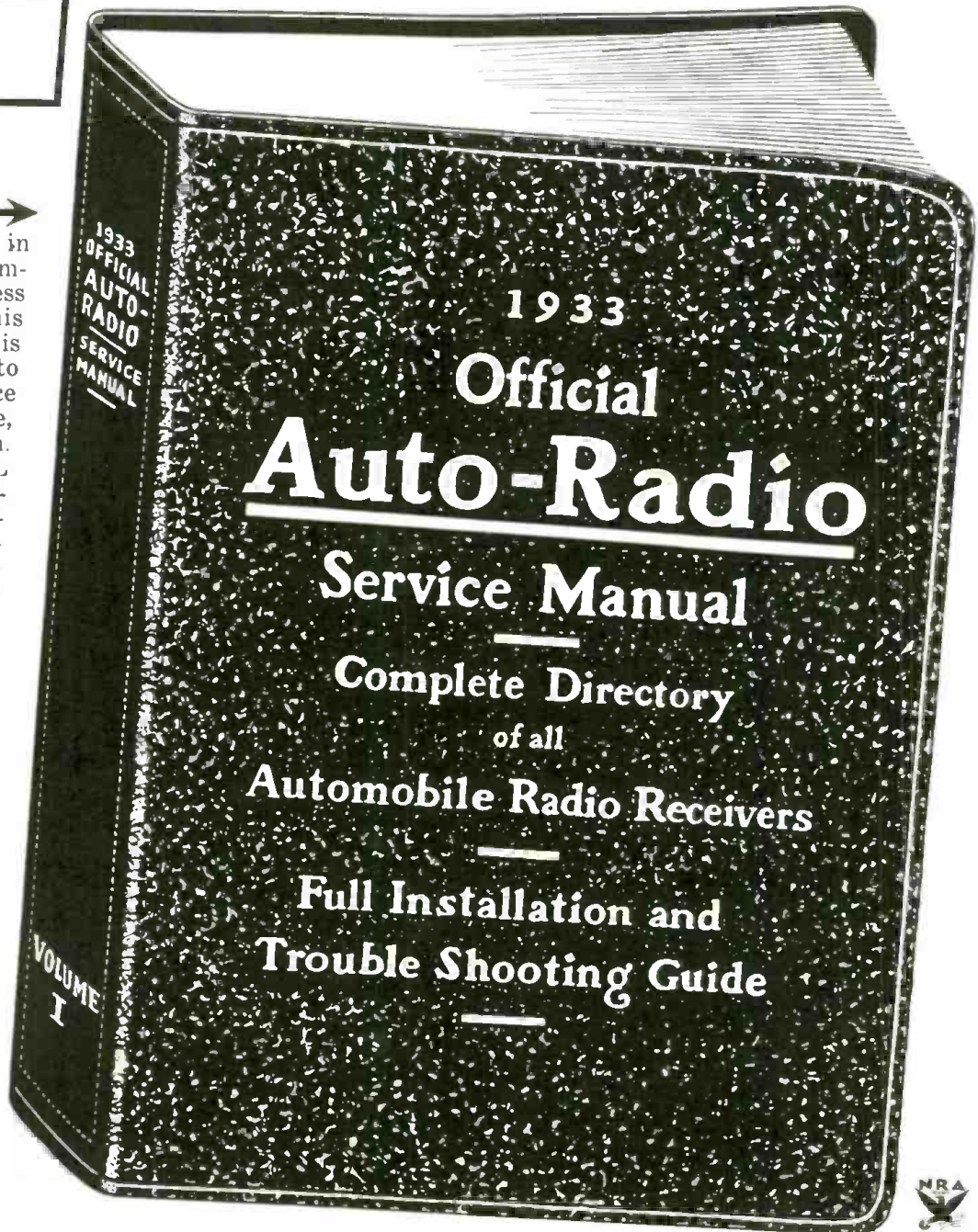

**\$2<sup>50</sup>**  
PREPAID

**MAIL THIS COUPON TODAY!**

GERNSBACK PUBLICATIONS, Inc.  
96-98 Park Place, New York, N. Y.

RC-11

Enclosed you will find my remittance of \$2.50 for which please send me one copy of the 1933 OFFICIAL AUTO-RADIO SERVICE MANUAL. (Send remittance in check or money order. Register letter if it contains cash or currency.)

Name .....

Address .....

City..... State.....

# RADIO-CRAFT'S INFORMATION BUREAU

SPECIAL NOTICE TO CORRESPONDENTS: Ask as many questions as you like, but please observe these rules:

Furnish sufficient information, and draw a careful diagram when needed, to explain your meaning; use only one side of the paper. List each question.

Those questions which are found to represent the greatest general interest will be published here, to the extent that space permits. At least five weeks must elapse between the receipt of a question

and the appearance of its answer here.

Replies, magazines, etc., cannot be sent C. O. D. Inquiries can be answered by mail only when accompanied by 25 cents (stamps) for each separate question; answers are subject to subsequent publication, if considered of exceptional general interest.

Other inquiries must be marked "For Publication."

## ELEVATOR LEVEL CONTROL

(221) Mr. Barbier Chase, Miamisburg, Ohio.

(Q.) How are photoelectric cells used to bring an elevator to a stop exactly at the floor level?

(A) The following information in connection with the Westinghouse Electric Elevator Company's installation in the RCA building at Rockefeller Center discloses the system used in photoelectric levelling of elevators.

The arrangement of the mechanism is shown in Fig. Q221A. The three respective positions which the apparatus may assume during the leveling of a car are shown in Fig. Q221B.

A small automobile headlight bulb is mounted upon a control panel on the side of the car. An "up" controlling photoelectric tube is mounted 3 ins. from, and on a horizontal line with the light bulb. A "down" bulb is mounted in a similar position on the opposite side. When the rays of light fall upon the "up" tube, the usual amplifier circuit is put into operation and the car moves upward; when they fall upon the "down" tube, the car descends.

Metal vanes fastened to the walls of the shaft, shown in Fig. Q221A and B, control the movement of the elevator. They allow the light rays to fall upon only one of the two light-sensitive tubes as the car slows down, and completely intercept the rays when the car reaches the correct floor level.

The photoelectric control does not begin to function until the car, slowing down for a stop, enters the zone of the metal vanes. If the car is descending, the upper vane, encountered first, prevents the light rays from falling upon the "up" controlling tube. When the car, still slowing down, reaches the lower vane, the "down" tube is cut off and the car immediately stops. The control works in a similar manner in stopping an ascending car.

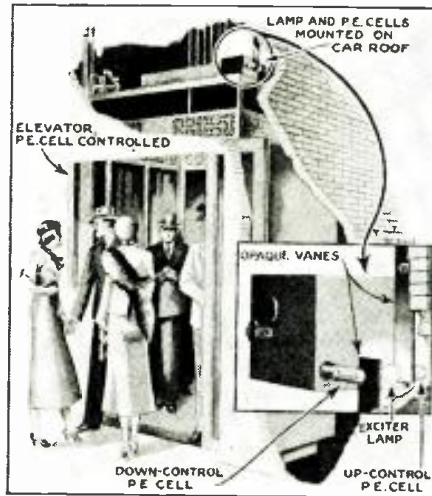

Fig. Q. 221A  
P. E. cell control of elevators.

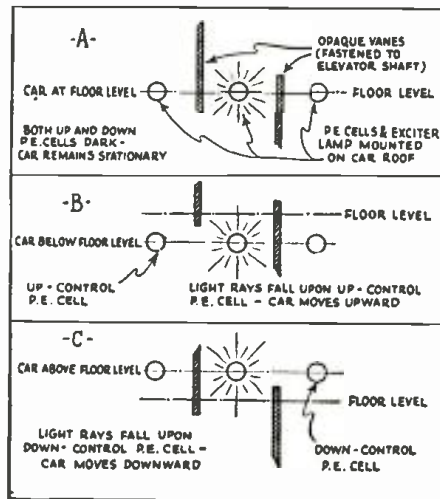

Fig. Q. 221B  
"Blinders" control the exciter lamp rays.

car of the operator might be left free to hear other sounds in the surrounding territory.

Good results are not obtained if the monitor beats against the fundamental frequency of the floating oscillator. With the instrument I am using, the monitor beats against the sixth harmonic of the floating oscillator, this note being much softer and easier to listen to; also, a greater frequency change is caused by the given change of inductance.

The chief trouble that the writer experiences seems to be in a slight drifting of the monitor which makes an adjustment necessary about every seven minutes; experiments are under way to prevent this drift. However, the latest "record" achieved by the writer with the apparatus described was the location of a gold watch at a distance of about 40 inches.

In order to obtain correct bias in the tube circuits, it is essential that four dry cells be used in order to obtain a 6 V. filament supply. However, some constructors have failed to follow the directions which call for the use of three, type 6-30 filament ballast resistors—result, a complete set of burned out tubes. Do not try to eliminate these resistors by reducing the filament battery voltage through the use of a fewer number of cells.

The metal box should be as solid as possible; the writer recommends 3/16-in. aluminum with the edges solidly bonded. In fact, it was essential to put ply-wood on the sides of the locator illustrated in the article since the case of that particular instrument was made of copper which sprang slightly and caused a change in wavelength as its relations to the detector coil varied. The joints of the copper can were welded in order to make a water tight container.

Further points of vital interest in the construction and operation of the metal locator described in the July, 1933 issue of RADIO-CRAFT are the following:

(1) Be very careful to do a neat wiring job, soldering every joint perfectly and lacing every wire down tightly in position. Use only stranded, rubber-covered hook-up wire; be sure the wire is well tinned. Do not try to use single-conductor wire.

(2) Use all the precautions customarily used in wiring high-gain superheterodyne radio receivers against undesirable radio frequency coupling.

(3) You will note a discrepancy in the illustrations used in the original story; one illustration, Fig. 2, shows the monitor oscillator coil mounted in the floating oscillator shield box; this is not correct as the monitor oscillator coil must be mounted in the monitor shield box together with its tuning condenser and associated parts, as shown in Fig. 1.

(4) The use of brass strips to mount the coils L1, L2, as shown, is not a recommended practice as the added capacity caused by the proximity of the brass to the windings may seriously affect the tuning and energy radiation of the floating oscillator. A better method is to place a block of wood against the end of the cabinet where the coil mounts in such a manner that the coil is held about 2 ins. away from the metal box; and in position, by leather straps.

(5) The copper screen shield around L1, L2, is a narrow strip, 1-in. wide, and is placed on the outside of the coil form. The instrument is somewhat more sensitive and has more penetrating power without this shield. Without the shield, however, the instrument is more "tricky" in its operation. The author was able to handle the instrument nicely without this screen shield after about two weeks field practice and made the most successful deep locations without it.

(6) Several builders have written to the author stating that the instrument does not oscillate. This may be due to one or more reasons. Try reversing the leads on the monitor tickler coil L4; this oscillator is nothing more than the old familiar regenerative detector operating at the point of sustained oscillation. Place a short piece of copper wire attached to the plate of V1, near a radio set antenna and tune the radio set until a beat note is heard from the monitor in the radio speaker; if a whistle is heard from the radio set, reset the monitor tuning condenser and try again. Do this

(Continued on page 313)

## "THE NEW 'TREASURE' FINDER" — CORRECTIONS

(222) Mr. W. U. Davis, Springdale, Ark. (Q.) I have built the "treasure" finder described by Mr. E. Franklin Sarver in the July, 1933 issue of RADIO-CRAFT, but I have been unable to get the circuit to oscillate. Please advise what may be the trouble.

(A.) We have received so many hundreds of inquiries concerning the metal locator developed by Mr. Sarver that we have asked him to prepare for the readers of RADIO-CRAFT a series of comments concerning the most likely troubles the constructor may encounter in building this sensitive instrument. The information furnished to us by Mr. Sarver is as follows.

Lack of appreciation, on the part of builders of the heterodyne metal locator, of the precision required in constructing apparatus of this nature, is the foremost "fault," if we may call it such, in operation of the device.

The writer has added a midjet variable condenser to the tuning system of the monitor in order to secure smoother action in controlling the beat note, the monitor tuning capacity now consists of a compression-type mica condenser of 350 mmf, maximum capacity, plus the midjet variable condenser.

One of the headphones has been removed and an impedance of equal value has been substituted in the instrument, so that one



# A NEW OSCILLATOR

(Continued from page 267)

If the A.F. circuit is functioning from that point on, the 1,000 cycle note will be heard in the speaker.

For I.F. amplifier tests the oscillator should be set to the correct frequency and the test lead connected to the grid of the first-detector. In some receivers, due to the nature of the A.V.C. circuit, it may be necessary to connect a condenser of about .01-mf. between the test lead and the grid to prevent shorting of the bias circuit.

With the above connection, it may be found that the signal cannot be heard or detected with the cord in the LOW jack. If so, it indicates that the receiver circuits are badly out of alignment and the HIGH jack should be used until the alignment is sufficiently good to allow hearing or seeing an indication of the signal with the line tip in the LOW jack and the R.F. output control set at maximum. As the various trimmers are brought to the point of resonance, the R.F. output control should be retarded, always using the lowest value of oscillator output that will give a satisfactory resonance indication.

For R.F. alignment, the line cord should be connected to the antenna post through a condenser to simulate an antenna. The receiver manufacturer's bulletin should be consulted as to the correct size of condenser to use; or, in the absence of this information, a 250 mmf. unit is suggested for use with standard broadcast receivers and 100 mmf. with auto-radio receivers. The same general procedure is followed in making this test that was used in making the I.F. test, using always the minimum possible setting of the R.F. output control.

The dial at the lower left-hand side of the panel is calibrated in kc. off resonance. In other words, with the selector dial set at 175 kc. and the selectivity dial set at 0, the frequency emitted by the oscillator is exactly 175 kc. and the selectivity dial set at 0, the to the left 10 divisions, the frequency will be 175 minus 10, or 165 kc. In the same way, if the selectivity dial is turned to the right—say 5 divisions—the frequency will be 175 plus, or 180 kc. The same action of the selectivity dial obtains at all settings of the selector dial. This unique feature permits the testing of the receiver for selectivity.

Many receivers are arranged in such manner that it is possible to stagger or distort the selectivity curve very easily in the course of what seems to be a normal alignment. (This is "flat top" resonance, as contrasted with "peak" response.—*Technical Editor*) This can easily be detected, by aligning the I.F. unit at, for example, 175 kc. and then shifting the frequency equal amounts to either side of the resonance peak, and noting whether the falling off in response is equal on both sides of the resonance curve, as noted in the output device. In addition, the selectivity dial can be used for obtaining some of the less-used intermediate frequencies if they are within ten kc. of the standard frequencies. For example, the 185 kc. test frequency can be obtained by setting the dial at 175 and the selectivity dial at plus 10 kc.

Sensitivity tests also may be made with this unit as the R.F. output attenuator is an accurately controllable instrument and the operator will find it possible to make notes on the response of receivers in terms of the setting of the attenuator. This means that if the setting of the R.F. output control necessary to give a certain output from the receiver is recorded, these values may be used for comparison of the sensitivity of the same receiver, or one of the same type, at a future date. Accumulation of data of this type is of great value to the Service Man, for its use makes it possible to ascertain the condition of a receiver as it is received from the customer. The use of a reference point is also of great value in the replacement of tubes in a receiver. Naturally, the tubes that permit the greatest output for the least value of input are the most suited for operation in that particular receiver.

All of the specified frequencies of this oscillator are rich in harmonics and provide a convenient means of checking and calibrating short-wave receivers. This is particularly

(Continued on page 300)



MODEL 674  
TUBE CHECKER



MODEL 665  
SELECTIVE ANALYZER

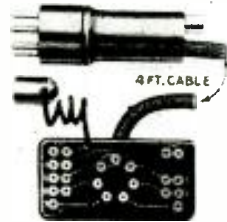

MODEL 666  
SOCKET SELECTOR

## OBSOLESCENCE WORRIES ARE ENDED *with this new test equipment*

Here is new test equipment that will never gather cobwebs because of obsolescence; never cost you real money in order to keep it up-to-date. The reasons are obvious:

The Weston Model 665 Selective Analyzer contains all the necessary voltage, current and resistance ranges. Separate Socket Selectors are provided to accommodate all 4, 5, 6 and 7 prong tubes. You merely attach the proper Socket Selector to the Analyzer, and insert the plug into the tube socket of the radio set. Then, by plugging into the proper jacks, voltage, current and resistance may be read in any part of the entire network leading to the tube socket. *New tube bases merely mean a new, inexpensive Socket Selector.*

The Weston Model 674 Tube Checker is a real tube merchandiser. It shows good tubes as "GOOD", and is beautifully finished in three distinct tones of brown. Provides for testing all present tubes; and has seven spare sockets which can be quickly wired in to test some fifty-odd additional tubes when and if offered. All reference to or knowledge of tube characteristics is avoided. Quick and accurate indication is obtained by simply following the few concise steps on the tube limit chart. Other features make it the outstanding value today.

Weston Model 666 Socket Selectors can be used with any and all makes of Analyzers. Your present Analyzer can be brought up-to-date, and kept that way, with these simple, inexpensive units.

These and other Weston Radio Instruments are illustrated and described in the new bulletin RA. Send the coupon today, and receive your copy... Weston Electrical Instrument Corporation, 599 Frelinghuysen Avenue, Newark, N. J.



# WESTON *Radio Instruments*

WESTON ELECTRICAL INSTRUMENT CORPORATION,  
599 Frelinghuysen Avenue, Newark, New Jersey

Please send circular RA containing full information on Weston Radio Instruments.

Name \_\_\_\_\_

Address \_\_\_\_\_

# AERIAL TOBE FILTERIZERS

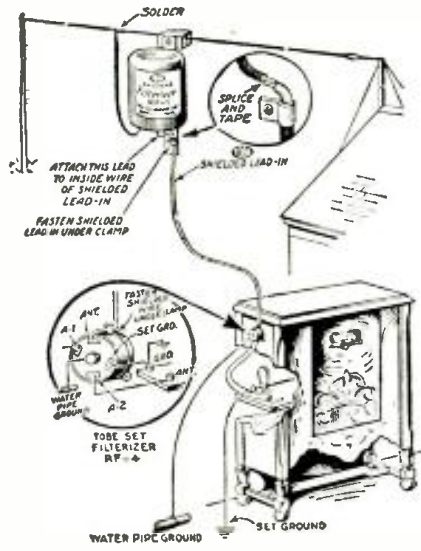

have helped thousands of radio listeners to obtain noise-free radio reception in locations where radio noise made even the best of sets useless. This remarkable product of the acknowledged authority on radio noise—the TOBE DEUTSCHMANN CORPORATION—guarantees satisfaction and real profits for you. Do not accept imitations or substitutes—insist on genuine TOBE FILTERIZERS, made by the one organization that has specialized in noise elimination and whose products are recommended by leading manufacturers throughout the nation.

We stock the complete line of TOBE FILTERIZERS and FILTERETTES, and are now the noise headquarters for the eastern United States. Send us all your noise questions and our noise experts working with Tobe interference engineers will tell you just how to stop the noise and make a profitable Filterette or Filterizer sale.



Eastern Headquarters  
for Tobe Filterette Division



**WHOLESALE RADIO SERVICE COMPANY, Inc.**  
100 SIXTH AVENUE NEW YORK, N. Y.

## NEW TUBES

(Continued from page 267)

classis space requirements.

Resembling in both function and operation, the 2A7 and 6A7 described in the July 1933 issue of RADIO-CRAFT, the 1A6 is subject to the same general operating requirements as those applying to other pentagrid converters.

The following operating conditions may be taken as typical, for two plate voltages.

Plate voltage	135	180	V.
Screen-grid voltage (grids Nos. 3 and 5)	67.5	67.5	V.
Anode-grid (grid No. 2)	135	135	V.
Control-grid (grid No. 4)	-3	-3	V.
Osc.-grid (Grid No. 1) resistor	50,000	50,000	ohms
Plate current	1.2	1.3	ma.
Screen-grid current	2.5	2.4	ma.
Anode-grid current	2.3	2.3	ma.
Oscillator-grid current	0.2	0.2	ma.
Total cathode current	6.2	6.2	ma.
Plate resistance	0.4	0.5	megohm
Filament voltage	2.0	2.0	V.
Filament current	0.06	0.06	A.
Conversion conductance	275	300	micromhos
Conversion conductance at -22.5 volts on grid No. 4	4	4	micromhos

The design of a superheterodyne receiver employing the 1A6 is conventional. There are no unusual features which must be taken into consideration. The R.F. input circuit, the I.F. transformers and the gang-tuning condensers are designed in the usual manner.

However, in designing oscillator coils for the 1A6, the coupling between the oscillator grid coil and plate coil may be slightly greater than that commonly used with triode oscillators.

In the illustration at the top of Fig. 1 are shown three standard methods; A, B, C, for constructing the oscillator coils. Each of the three coils shown has an M/L ratio (the mutual inductance, M, between the oscillator anode-tuning coil, L2, and the oscillator grid-tuning coil, L1, to the inductance, L<sub>a</sub> of the oscillator grid-tuning coil, L1) which will

give satisfactory operation of the 1A6. The coils are suitable for use with an I.F. of 175 kc. in a broadcast-band set. The use of other intermediate frequencies will necessitate changes in the inductance of the coils. Usually coils which are suitable for the 2A7 or 6A7 will be satisfactory for this tube.

The oscillator anode-grid voltage must not exceed 135 V. If the oscillator anode-grid is supplied from a plate voltage source of more than 135 V., a voltage dropping resistor must be used. With 180 V. plate supply, a 20,000 ohm voltage dropping resistor in series with the oscillator anode-grid, and shunted by an 0.1-mf. condenser, will reduce the voltage to a permissible value.

In general, decreasing the voltage on grids Nos. 3 and 5 from 67.5 V. will decrease the gain. The screen-grid voltage must, however, never exceed 67.5 V. under any conditions of operation. The optimum value for screen-grid voltage is dependent on the other electrode voltages and on the circuit constants. Thus, all currents will increase with increasing screen-grid voltage. A reduction in the oscillator grid-leak resistance increases the gain and at the same time, the currents. And, an increase in the M/L ratio of the oscillator coil operates in the same way.

The total cathode current in the 1A6 should never exceed 9 ma. Varying operating conditions to raise the cathode current above 6.2 ma., as shown in the circuit, in Fig. 1, for typical operating conditions, usually will not increase the gain appreciably. Consequently, more satisfactory operation of the 1A6 is obtained with approximately 6 ma. cathode current, since higher values tend to shorten the life of the tube.

In the lower part of Fig. 1 are shown, left, the socket connections, and, at right, the tube elements of the 1A6. A "cathode effect" exists between G2 and G3. This is the "virtual cathode" described, and illustrated in Fig. 3F, in the July issue of RADIO-CRAFT previously mentioned.

Referring again to the schematic circuit in Fig. 1, the ganged condenser C1 and C2 are

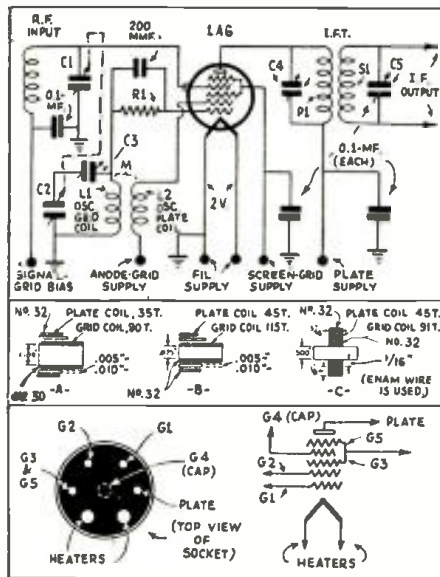

Fig. 1  
Circuit and coil details for the 1A6 tube.

standard signal- and oscillator-frequency tuning units, respectively.

Condenser C3, a "padding" unit, is not required if condenser C2 is "shaped." Condensers C4 and C5 are the usual I.F. trimmers, with a minimum capacity of 50 mmf., as stated below.

Complete shielding is essential to prevent interstage feedback. The filament voltage should never be permitted to exceed 2.15 V.

The bias voltage applied to grid 4 can be varied over relatively wide limits to control the translation gain of the tube. For example, with 67.5 volts on the screen (No. 3 and No. 5), the bias voltage may be varied from -3 to plate current cut-off (approximately -25 volts). With lower screen voltages, the cut-off point is proportionally less. The extended cut-off feature of the 1A6 in combination with the similar characteristics of super-control tubes can be utilized advantageously to adjust receiver sensitivity.

Since the capacity between grid No. 4 and plate is in a parallel path with the capacity and inductance of the plate load, P1, it is important to use a load capacity, C4, of sufficient size to limit the magnitude of the R.F. voltage built up across the load. If this is not done, R.F. voltage feedback will occur between plate and grid No. 4 to produce degenerative effects. For this reason, the size of the load condenser in the plate circuit should be not less than 50 mmf.

Converter circuits employing the 1A6 may easily be designed to have a translation gain of approximately 40. The typical schematic circuit shown in Fig. 1 provides exceptionally uniform oscillator output over the entire grid-bias range.

#### The 6C6

Another new tube is the 6C6 triple-grid amplifier and detector: it is an efficient R.F. pentode having a sharp cut-off. It is similar to the type 57, except for the heater rating. This tube is recommended for use as a detector, or as a second-detector-oscillator in superheterodyne receivers; also as a control tube and as an A.F. amplifier with resistance coupling.

Typical operating characteristics for this tube as a class A amplifier are as follows:

Heater voltage	6.3 V.
Plate voltage	250 V.
Screen voltage	100 V.
Grid voltage (for cathode cut-off)	-7 V.
Grid voltage	-3 V.
Plate current	2 ma.
Screen current	0.5 ma.
Plate resistance	1.5 megohms
Amplification factor	1500 (min.)

As a biased detector, the 6C6 has these characteristics:

Heater voltage	6.3 V.
Plate voltage	250 V.
Screen voltage	100 V.
Grid voltage	-6 V.
Plate current	0.1 ma.

Plate load, 0.25-megohm or a 500 ohm, choke shunted by an 0.25-megohm resistor for resistance load; the plate voltage will be the plate supply voltage minus the voltage drop in the load, depending on the plate current.

#### The 6D6

Then there is the new 6D6, a triple-grid variable-mu amplifier; it is a remote cut-off tube, otherwise similar to the 6C6. It is designed for R.F. and I.F. amplification, or for use as a first-detector in superheterodyne receivers. In this latter service, the translation gain is lower than that obtained from the 6C6, but A.V.C. potentials may be applied to this tube to secure increased range of control. Except for the heater rating this tube is similar in operation and characteristics to the 58 tube.

Typical operating conditions for the 6D6 are given below.

Heater voltage	6.3 V.
Plate voltage	250 V.
Screen voltage	100 V.
Grid voltage	-3 V.
Plate current	8.2 ma.
Screen current	2 ma.
Plate resistance	0.8 megohm
Amplification factor	1280
Mutual conductance	1600 micromhos



## THE PHILCO SET TESTER

### uses the Westinghouse Universal Instrument

**T**he instrument used in the Philco "All-Purpose" Set Tester is a standard Westinghouse universal Rectox milliammeter.

This instrument provides, by the use of shunts and resistors:

- 5 a-c. voltmeter scales—0-10, 0-20, 0-100, 0-200, and 0-1000 volts.
- 5 d-c. voltmeter scales, in the same ranges as for a-c.
- 3 d-c. milliammeter scales—0-0.5, 0-1, and 0-100 milliamperes.

3 ohmmeter scales—0-1500, 0-150,000, and 0-1,500,000 ohms.

5 a-c. output scales.

The instrument is flush-mounting, in a molded case 3½ inches in diameter, and 2⅞ inches deep. D-c. scales are black and a-c. scales are red, for quick identification. When used as a voltmeter, the sensitivity is 2000 ohms per volt. Accuracy is within 2 per cent.

Send the coupon today for more complete data and prices on this instrument.

## Westinghouse

*Quality workmanship  
guarantees every Westinghouse product*



#### SEND FOR INFORMATION

Westinghouse Electric & Mfg. Company  
Dept. 108, Room 2-N—East Pittsburgh, Pa.  
Gentlemen: Please send me information on:

- Philco Set Tester.
- Universal Rectox Instruments.

Name.....  
Address..... T 79711  
City..... State..... RC 11-33

Be sure to turn to page 293 of this issue and read about the new 1933 OFFICIAL AUTO-RADIO SERVICE MANUAL which is now published.

### WANTED!

Jobbers—Mail Order Houses and Representatives  
in all Territories

### TWO FAST MOVERS



Free Edge Cone and Voice And—Field Coils for all  
Coil Assemblies Dynamic Speakers  
We also Manufacture Various Types of  
Magnetic Speakers

We can Supply and Remedy Your Speaker Needs.  
Speaker Mfrs. Since 1921

LEOTONE RADIO CO., 63 Dey St., New York, N.Y.

### WANTED

—every radio service man, set builder and experimenter to have the helpful Hammarlund Catalog of precision products. Write Dept. RC-11 for free copy. Also, if interested in the most efficient shortwave receiver ever devised, ask about the COMET "PRO" Superheterodyne with Crystal Filter.

HAMMARLUND MFG. CO.  
424 W. 33rd Street  
New York, N. Y.

## For Better Radio Hammarlund PRECISION PRODUCTS

# FIXED better with ...

## Centralab FIXED RESISTORS



More and more servicemen are being "wised up" to the fact that they can do a better job with CENTRALAB Fixed Resistors. For these sturdy, dependable resistors are BAPTIZED WITH FIRE and stand up under strains and abuses that would make the average resistor give up and quit. So be sure to specify CENTRALAB when next you order your stock of replacement resistors.

**Centralab**  
CENTRAL RADIO LABORATORIES  
MILWAUKEE WISCONSIN

## Give SERVICE

... with a Small Inventory

Here is the best Volume Control Proposition on the Market. Here are the reasons why?

1. Over 400 "exact duplicate" controls in the "X" series.
2. Yet with SIX controls in the original-AD-A-SWITCH-SERIES 477 sets can be serviced.
3. By combining controls in both lines any requirement can be met with minimum stock investment.
4. Clarostat with its two separate lines offers the widest range of controls to choose from.
5. Clarostat Controls are inseparable from Quality Service Work.

Clarostat "X" line has over 400 controls to choose from—exact as to electrical overall resistance, taper, bushing, shaft length, and will fit into exact space in set.

Clarostat Ad-A-Switch line comprises the maximum utility with minimum stock investment. Series W (Wire Wound) obtainable from 50 to 50,000 ohms. Series C (new composition element) obtainable from 10,000 to 5,000,000 ohms. Both lines obtainable in all tapers—insulated shaft 1 1/2" long. Wide use is indicated as follows: W-28 will service 128 sets; C-28 will service 108 sets; W-29, 77 sets; C-29, 66 sets; etc., etc.



NEW CONTROL  
REPLACEMENT GUIDE  
ON REQUEST

**CLAROSTAT MFG. CO., INC.**  
287 North 6th Street, Brooklyn, N. Y.  
AD-A-SWITCH was originated by Clarostat.

An even more recent series of tubes that are *spray shielded* permit the design of receivers which do not require the use of external shield cans. These tubes are designated as the 6C7, 6D7, and 6B7.

### The 6C7

The 6C7, a duodiode-triode tube, is identical to the type 85, but is equipped with a shield of molten metal *sprayed on the glass envelope*. This shield is connected to an extra prong on the tube base, between the diode plate nearest the cathode, and the cathode, which necessitates the use of a small 7-prong socket.

The 6D7, a triple-grid amplifier and detector tube, is similar to the 6C6, described above, except for the addition of a spray shield on the glass envelope. This shield is connected to an extra prong on the base, between the suppressor-grid and the cathode. A small 7-prong socket is required.

The 6E7, triple-grid super-control amplifier tube, is similar to the 6D6 described above, except for the addition of the spray shield and its connection prong.

## A RADIO ROBOT

(Continued from page 271)

### Installation Difficulties

While the operation of this system sounds complicated, it is really simple, compared to the task of designing and installing it. In the first place, the building is located in a D.C. district. Both the telektor units and the combination radio and phonograph are designed for A.C. operation, which necessitates the use of a converter unit. A 500-watt motor-generator set is used for this purpose. However, this latter device could not be turned on separately as this would complicate the operation of the system. (It must be remembered that the radio equipment was installed for people who know nothing about the technicalities of radio.) To overcome the difficulties involved, a special master relay has been installed in the receiver and is connected to the various telektor units as well as the program machines. This relay is operated by the D.C. line, and as soon as the contact to the converter unit is made, the D.C. circuit is broken and the contact held by the A.C. output from the converter. All other circuits (except the field current for one of the loudspeakers) are opened from this converter.

To understand some of the difficulties involved in engineering the installation of this system, a block layout, Fig. 1, has been made. This layout does not show the actual wiring, as it is naturally much more complicated than the diagram shows. It will be noticed that the radio set, one reproducer, and one telektor unit are located in the "conference room"; the master clock, gong, and program machines are in the office. The second speaker and telektor are located on the roof, while the third speaker and telektor, together with the second gong, are located in the "apartment."

The speaker selector relays which are located on the floor below the apartment and offices are shown in Fig. D. The complications of the installation are apparent from this photograph. You will note that there are nine armored cables running from these three relays with the associated connector block.

### The Three Outlets

As we mentioned before, three speakers with their associated telektor units make up the remote control feature of the installation. The mechanical installation of these speakers is novel. The radio set, shown in Fig. E, one reproducer and the telektor unit shown in Fig. A, are located in the "conference room." However, the tuning controls on the receiver are never touched as the location of the telektor box is much more convenient. Those who have read the previous article describing the telektor system know how simple it is to turn the set on and tune to the stations for which the unit has been set.

The second speaker is located on the roof, midway between the gymnasium and the roof garden. As shown in Fig. F, it is equipped with a long cable which winds itself automatically on a spring reel. Thirty feet of 3 conductor cable are provided on the reel, and

(Continued on page 301)



Books and lectures on the marvelous accomplishments of the Photo-electric cell must inspire you, but only by experience with the actual device can you get the FEEL of a Photo-cell; only by owning and working with the tools of Photo-electricity (a complete kit) can this science become a powerful reality rather than the intriguing mystery that it must be to you now.

Years of experience manufacturing Photo-cells and allied instruments have placed us in a position to supply the most dependable apparatus known. The Kit we offer consists of only the highest quality merchandise; a Photo-electric cell, amplifying tube, magnetic relay, condenser, resistors, socket; everything that is essential for the ideal unit, though your problem is to control illumination, detect burglars, count articles in production, guard machinery or accomplish any of the innumerable feats which are practical for Photo-cell control.

Our price is an achievement in itself.  
\$8.00 the complete kit.

**THE CLARK INSTRUMENT CO.**  
CAMDEN, N. J.

## PRACTICAL RADIO ENGINEERING

An opportunity for  
RADIO MEN to en-  
large their scope of  
training.



Whether elementary radio principles or advanced subjects, sound applications or practical radio engineering, RCA Institutes is prepared to give you the instruction you need.

RESIDENT SCHOOLS NEW YORK AND CHICAGO  
with modern standard equipment

EXTENSION COURSES FOR HOME STUDY  
under convenient "no obligation" plan.  
Illustrated Catalog on Request

**RCA INSTITUTES, INC.**

Dept. RT-11

75 Varick Street, New York  
1154 Merchandise Mart, Chicago

### HOW'S THE QUALITY?

Tone quality is too precious to sacrifice. It should be your first consideration in purchasing condenser microphones. It is the first consideration of Chrsell-Acoustic Laboratories in building them. That is why we can say "Compare the Chrsell-Acoustic microphone with any other, even at twice the price. Your money refunded if you find a microphone of better tone quality."

**WE ARE PROUD OF OUR PRODUCTS—**  
We know the painstaking skill, the careful designing, the ruggedness, and the beauty which is part of them. You'll appreciate it. For instance, the C-A 9—beautiful in tone and appearance, solidly built, precision machined head, highly polished, lacquered aluminum shell shields a high-gain 2-stage pre-amplifier using latest type tubes. All A.C. operated. Response, 40 to 10,000 c.p.s. High sensitivity, no hum, 200 and 500 ohm output. Advanced design. Will operate from main amplifier power supply. Very attractively priced. Write for Folder B, describing this and other condenser microphones, including build-your-own kits. Folder B.  
**CHRSELL-ACOUSTIC LABORATORIES**  
9260 Fifth Avenue Brooklyn, N. Y.

SEND FOR  
FREE  
RADIO  
CATALOG

COAST TO COAST RADIO CORPORATION  
125 WEST 17th STREET  
NEW YORK, N. Y.

THE CONSOLIDATED OFFICIAL RADIO SERVICE MANUAL is the only complete, right-up-to-the-minute ONE VOLUME BOOK on radio servicing. It contains over 2,300 pages, over 5,500 diagrams, charts and photos. Full details about this great book will be found on page 262.

## RADIO REVIEW

(Continued from page 268)

the amplifier. It will be noticed that one of the type 56 tubes, V3, has its grid connected, through C, into the cathode circuit of the diode-triode, V1. As the current flowing in this circuit is 180 degrees out of phase with that in the plate circuit, the necessary phase opposition is achieved.—*Editor*.

These in turn, drive a pair of 47 type pentodes. The 200 ohm wire-wound resistor is called upon to carry a fairly heavy current, and on this account needs to be rated to carry 100 ma. The remainder of the resistors should be of 1 W. size.

(Readers will notice that the tube types mentioned are the same as the American types. American tubes are used almost exclusively in Australia.—*Editor*).

### The International Radio Review

IN THE April and May, 1931, issues of **RADIO-CRAFT** we described a radio receiver designed by the British Broadcasting Company's engineers which was made to produce as nearly perfect quality as possible. The description of this receiver created such marked interest that we are sure many of our readers will be pleased to study the new circuit of this simplified "Perfect Quality" receiver, which appeared recently in **WIRELESS WORLD**, London, England.

The diagram, Fig. 3, shows the general arrangement of the set; it is not proposed to deal with the power unit as this unit follows convention and gives an output of 350 V., filtered D.C.

The detector arrangements are also quite normal and the R.F. side is designed to receive only two local English stations; a single-circuit tuner was used, this being de-normal, and the R.F. side is designed to sirable because the receiver was designed for fixed tuning, switching from one station to the other being accomplished by relays which switch in fixed condensers.

In order to obtain push-pull operation from a pair of output vacuum tubes it is necessary to introduce a "lag" of 180 degrees in the grid voltage of one of them so that it will work opposite the other. In other words when one grid receives a positive impulse, the other should receive a negative one. With the usual A.F. transformer type of coupling, this is easily obtained by using a center-tapped transformer, but, where resistance coupling is used, this can be effected by taking advantage of the principle that the A.C. voltage component on the plate of an amplifying tube is 180 degrees out of phase with that on the grid.

The input voltage is applied, therefore, to the grid of one tube, say to point Y in the diagram, and a portion (in this case about 4 per cent) of the amplified voltage, which is now 180 degrees out of phase, is coupled, through C5, into the control-grid circuit of the second chain of amplifying tubes. This is accomplished by tapping off a portion of the voltage difference between the tube plates of the first stage by means of potentiometer R9.

The success of the operation of the amplifier depends on the correct balancing of the circuits—that is to say, considering the first stage, the audio frequency voltage on the grid of one tube must be equal and opposite to the A.F. grid voltage on the other. If this is done, the A.F. voltages on the plates of these tubes will be equal and opposite in phase, providing that the amplification of each tube with its associated condensers and resistors is the same.

Similar remarks, of course, apply to the output tubes. If correct balance is attained in this part of the circuit, there should be no A.F. currents in the common positive feed to any stage; or in the common negative feed from the stage. This is easily tested in the first stage by the insertion of a pair of phones at the point X, and the potentiometer R9 is moved so that a minimum signal is heard in the phones, the tubes having been temporarily removed from their sockets. If, now, the tubes are replaced and if each amplifies the signal to the same extent, there

should be no signals heard in a pair of phones connected, as shown in dotted lines, to the center-tap, Z, of resistors R18 and R19 across the output transformer. This arrangement is virtually the same as in the first stage, except that the heavy plate current of the output stage is prevented from flowing through the phones, the point Z being at the same A.F. potential as the center-tap of the primary of the output transformer.

It is interesting to note that if R9 is varied, so that an out-of-balance of, say, 20 per cent is produced (a guess) instability is noticed in its effect on the quality of reproduction, and if this value is exceeded motor-boating will set in, especially when the amplifier is working as a local-station receiver.

The values of parts for the set are as follows: Tubes—MIU's in the first stages, with PXC output tubes (not obtainable in the U. S.); however, other more available tubes may be used. Resistors P1, P2, 50 ohm potentiometers; R1, R2, 600 ohms; R3, 250 ohms; R4, 300 ohms; R5, 400 ohms; R6, R7, R15, 30,000 ohms; R8, R10, R12, R13, R14, R17, R24, .25-megohm; R9, 50,000 ohms; R11, 2 megohms; R16, 20,000 ohms; R18, R19, R22, R23, 10,000 ohms; R20, R21, 100 ohms; R25, 10 ohms. Condensers C1, C2, .012-mf.; C3, C4, C6, 2 mf.; C5, .01-mf.; C7, .05-mf.; C8, 300 mmf.; C9, C10, 500 mmf.; C11, 100 mmf.; C12, .01-mf.

## THE "RESONATOR"

(Continued from page 269)

of pitch, in this instance, a tuning fork) over a long test tube, and pouring mercury or water into the tube; there comes a moment when the tube vibrates very strongly and considerably reinforces the sound which is being produced by the diapason. If one continues pouring the liquid, the system stops resonating at the fundamental frequency of the diapason but reinforces, in succession, other musical notes which are the odd harmonics of the fundamental note.

A similar experiment may be demonstrated by using as the resonator a two-section pipe open at both ends and sliding one section back and forth inside the other. In this manner it is possible to reinforce the entire sequence of the harmonics of the fundamental note. It is in the application of these general principles upon which are based many musical instruments such as the keyboard, saxophone, trombone, clarinet, flute, hunting horn, organ, etc.

In passing, it may be well to mention that a very narrow pipe resonates only to the harmonics of the exciting sound while broad pipes resonate only at the fundamental frequency; organ pipes reinforce only the fundamental sound. The timbre of the exciting sound is materially changed by the characteristics of the resonating system and this modification is dependent upon the following factors: (1) The shape of the hollow in the pipe; the rigidity of its sides; the internal polish of the pipe; and the ratio between the diameter and the length of the pipes.

Most reproducers have a number of dead spots at the high-frequency end of the scale at which the sound output is so feeble as to considerably change the timbre of reproduction. This is particularly noticeable when listening to vocal and instrumental soloists. However, it is possible to build a system of resonators so designed as to reinforce these particular weak points in the reproduction.

A big step forward in this direction was Dr. Volf's use of a dynamic reproducer in conjunction with an exponential horn and a resonating system, as described by Lawrence M. Cockaday in the article, "New Developments in Reproducers," which appeared in the May, 1930 issue of **RADIO-CRAFT**. More recently, there has been developed a system of resonating tubes which correspond precisely in their fundamental frequencies with the notes of the chromatic scale, and a standard dynamic reproducer, as illustrated in Fig. A. A more detailed illustration is Fig. 2, which shows the manner in which the dynamic reproducer is placed in relation to the resonating tubes. As shown in Fig. 2, the reproducer is placed



## N. U. Scientist Perfects Ultra Violet Lamp

Special Installations Seen As Money Maker for Service Men

Chief Engineer, Dr. E. A. Lederer of National Union has developed a constant source of vital ultra violet wave lengths in the new Lederer Ultra Violet lamp types D-30 and X-30 announced this month by National VitaLite Corporation, affiliated with National Union Radio Corporation.

These lamps are the crowning achievement of two generations of scientists. Work on the Lederer lamps was started in Vienna, Austria, about 1910 by Dr. Anton Lederer, father of National Union's Dr. E. A. Lederer. The developmental work was picked up by Dr. E. A. Lederer at the time of his father's death in 1932. With a background of experience with Westinghouse in vacuum tube and lamp engineering, dating back to 1921, the son was well equipped to carry through the father's work. Applying his highly specialized modern radio knowledge against the background of his father's hundreds of experiments, Dr. E. A. Lederer produced two types of lamps approaching the ideal for ultra violet wave production. Both lamps are the same in basic construction, the difference being in the kind of glass used in the bulb.

The Lederer D-30 is a medium fast tanning lamp and the X-30 a fast tanning lamp. They operate at low voltage and therefore require the Lederer Type T-30 Transformer to permit use on 110 volt 60 cycle alternating house current.

The Ultra Violet waves are produced when a rare gas with which the lamps are filled comes in contact with mercury vapor created by heat from the two electrodes in the bulb.

The Lederer lamps are safe and as easy to operate as an ordinary house bulb.

Individual parts can be purchased separately so that with a few necessary parts the service man can make special home installation at a minimum cost.

Every service man should investigate as a source of additional revenue.

Further details will be supplied upon request addressed to National VitaLite Corporation, 400 Madison Avenue, New York, N. Y.

## SHOP EQUIPMENT FREE THRU N. U.

National Union offers the new Hickox Simplex Portable Tube Tester, an Automobile Radio Service Manual, Supreme Model 333 Combination Set Analyzer and Resistance Tester, three Radio Service Manuals, ABC Unameter Tube Tester, Oscillator and Output Meter, Bench Kit Box and a Readrite Tube Tester. FREE with purchase of National Union tubes. Deposit on some items. Send coupon for full details.

For your convenience—National Union jobbers stocks are complete! All types at all times.

All offers subject to withdrawal without notice!

National Union Radio Corporation of N. Y. 400 Madison Ave., New York, N. Y.		
Gentlemen: Tell me how I can take advantage of your equipment offers.		
NAME .....	RC11	
STREET .....		
CITY .....	STATE .....	

# RADIO for 1934

## NO SERVICEMAN DEALER OR SET BUILDER CAN AFFORD TO BE WITHOUT THIS BOOK

Send for the most valuable book in Radio. Packed with quality and value. Lists the most complete line of radio replacement parts for any service requirement. Features latest type set-building kits, test instruments, Long and Short Wave Radios, Sound Systems, etc. Write for this FREE Catalog today!



# FREE

### ALLIED RADIO CORP.,

Dept. D, 833 W. Jackson Blvd.  
Chicago, Illinois.  
Please send me FREE your New 1934 Radio Book.

Name .....

Address .....

City..... State.....

## Allied Radio

# "Holy Smoke!"

is what everybody says when they read this letter

**J. T. WARING**  
Radio Engineering  
850 Southern Blvd., N. Y. C.  
July 21st, 1933  
Mr. Arthur H. Lynch,  
Lynch Mfg. Co., Inc.,  
51 Vesey St., N. Y. C.

Dear Mr. Lynch:  
It is not this writer's custom to burst into flowery phrases or compliments promiscuously. However, your products are positively THE best that we have ever used. We have been engaged in research work on some special power amplifiers utilizing Class "A" Prime Amplification. In so doing we have experienced considerable difficulty with the resistors that we have been using. Recently, however, we switched to Lynch Resistors and it is my pleasure to inform you that we are more than pleased with the results.

With best wishes for continued success, we are Very truly yours,  
(Signed) J. T. Waring

## LYNCH RESISTORS

Universally Accepted where the BEST is standard

Prices of LYNCH Resistors to Jobbers, Dealers and Servicemen no higher than prices of ordinary resistors.

Free Descriptive Folder Upon Request  
**LYNCH MANUFACTURING CO. Inc.**  
51 Vesey Street, New York, N. Y.

on a horizontal baffle in such a manner that the sound waves, leaving the front of the cone, are caused to directly actuate a bank of high-frequency resonant tubes placed directly above. The low-frequency output from the opposite side of the conical diaphragm sets into vibration a set of low-frequency tubes located at the periphery of the baffle. The relation of these two sets of tubes is understood by comparing the front cross-section view, A, with the side cross-section view, B. Both sets of tubes are placed parallel to each other and in a vertical plane; the relation of each tube with regard to the cone is calculated so that it corresponds to the best position in which it is to be driven; tubes of neighboring musical frequencies are placed on symmetrical extremities. In this way there is no loss of sound energy and, on account of the length of the resonating tubes, there can be no interference between two sources of sound.

The acoustic coupling between the upper and lower sound-chambers, C1 and C2, respectively, and both sets of resonators, may vary; it is only necessary to change the position of a moving part that constitutes the "floor" of the upper chamber and the "ceiling" of the lower one. With the aforementioned design the dynamic driving unit is working in an enclosed area; and the cone functions as a piston. The resonating tubes required to cover all the notes of the piano scale range in size from 16 ft. for low C 132 cycles to 3/4-ft. for A in the sixth octave (3,344 cycles).

Although this reproducer design may be used in small models, best results are obtained when the instrument is designed for a power input to the motor unit of about 5 W., minimum. For best reproduction of the very low notes, the optimum height for the tubes must be used. Thus, the finished reproducer may range in size from the small instrument illustrated in Fig. A, which measures 24 x 40 ins. high, to larger models measuring about 55 x 70 ins. high. Consequently, the resonator loudspeaker, as designed at present, is best adapted for use in theatres, halls, and wherever else these factors of large dimensions and high power output are desirable and convenient. A particularly satisfactory installation of a resonator reproducer includes the use of two different units, one designed for voice reproduction and the other for orchestral frequencies.

A fine musical instrument may be made by combining a resonator reproducer with a high quality microphone, an A.F. amplifier, and a harmonium of good quality with 24 stops, 2 key-boards, and a pedal. Such an instrument has the acoustic quality and power output of a large organ of which, with its double key-board, pedal operation, etc., it has the outward appearance. Still, it has for the player a larger variation of amplitudes than can be obtained in the ordinary organ; also, by the operation of tone controls in the electrical circuits, it is possible to vary the tone quality within wide limits. The same general ideas may be applied to an ordinary piano, converting it into what might be aptly termed a "super" piano.

## A NEW OSCILLATOR

(Continued from page 295)

convenient with the 1,000 kc. and 1,500 kc. test frequencies. The harmonics of the 1,000 kc. frequency are conveniently 1 megacycle apart, so that it is handy to start testing and calibration at say 2,000 kc. on the receiver. With this point located, the 3,000 kc. calibration is located from the third harmonic of the 1,000 kc. test note. To confirm this point, the selector dial can be changed to 1,500 kc. to see if the second harmonic of this note is heard at the same point on the receiver dial. The selector is reset at 1,000 kc. and the 4,000 kc. and 5,000 kc. on points on the receiver dial located. At 6,000 kc., the actual frequency can again be definitely established by using both the 1,000 and 1,500 kc. notes to be certain of the actual harmonic that is being used. This convenient method of checking the order of the harmonic being used eliminates any possible errors due to the mistaking of spurious responses of the receiver for actual harmonics of the oscillator.

## Another TRUMAN AUTO MODEL 7-TUBE SUPER

6" Speaker

List Price ..... **\$45.00**

Short Wave and Broadcast Midgets

Write for Dealers' Discounts

**TRUMAN RADIO SHOP**  
7443 STEWART CHICAGO, ILL.

### MAKE A LOUD SPEAKER SYSTEM out of any Radio Set having a monograph connection - MODEL QRXF

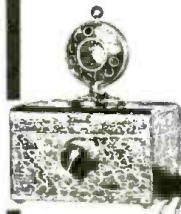

consists of microphone, transformer, volume control and battery receptacle—all completely assembled in a box with 15 ft. of cord for connection. Not a novelty or toy, but a real microphone and transformer combination that gives real results. Now reduced to \$7.50 List.

Standard Discount UNIVERSAL Microphone Co., Ltd.

421 Warren Lane, Inglewood, Calif., U. S. A.

### World-Wide Two Tube Short Wave Receiver



12,500 Mile reception record established! Tunes from 15 to 200 Meters. Gets foreign broadcasts, police calls, airplanes, amateurs, etc. DIRECT! Complete KIT (no drilling) with clear instructions to build this remarkable 2 tube receiver.....\$4.75

175 volt or AC model. Send \$1.00 balance C.O.D. Satisfaction Guaranteed! Send for FREE Short Wave Catalog.

Harrison Radio Co., Dept. R11, 142 Liberty St., N.Y.C.

## New 108 PAGE free 1933 RADIO CATALOG

Replete with BARGAINS GALORE for DEALERS - SERVICEMEN - AMATEURS. Send for Your Copy TODAY!

TRY-MO RADIO CO. 85 CORTLAND ST. NEW YORK CITY Dept. C.

### SERVICEMEN!

THE MOST COMPLETE LINE OF CONDENSERS AND RESISTORS FOR EVERY RADIO USE. Write for our new 8-page Catalog folder free of charge.



76 Washington Street Brooklyn, N. Y.



SERVICE MEN: New! EX-STAT 20-watt wire-wound resistors. Same size as ordinary 3-watt resistors. Post card today brings bulletin.

Tilton Manufacturing Co. 17 East 26th Street, New York

## GET THE BIG RADIO CATALOG

THE RADIO SUPPLY WORLD IN 148 BIG PAGES just out for you! Make your request for it on your Dealer's, Service Man's, School's, Experimenter's or Amateur's letterheads. Order from America's Largest Radio House in America's Handiest Shipping Point.

**BURSTEIN-APPLEBEE CO.**  
Dept. A-1 1012 McGee St. KANSAS CITY, MO.

## Sensitivity SHURE Tone Quality MICROPHONES

**SHURE BROTHERS COMPANY**  
Manufacturers of MICROPHONES Chicago, Ill. (Incorporated in U.S.A.)  
215 WEST HURON ST. CHICAGO, ILLINOIS

## A RADIO ROBOT

(Continued from page 298)

an additional 50-foot cable may be attached so that the speaker may be moved to any part of the spacious roof. The telektor unit is provided with a 10-foot, flat canvas connector strip and may be used either in the roof garden, or the outdoor or indoor gymnasiums, by passing it through the small doors provided for this purpose.

The third speaker is located in Mr. Powers' apartment and is cleverly installed in the wall so that it may be heard either in the bedroom or the hallway leading to the bath. It was originally planned to install individual speakers in these two rooms, but this plan was abandoned when it was discovered that the fourth speaker would complicate the installation a great deal.

A compromise was made by installing cello-tex-lined doors in the wall behind the bedroom speaker, so that the programs could be heard in the bathroom when desired, by simply opening the doors. This arrangement is shown clearly in Fig. 6.

Figure 11 shows the roof speaker and telektor units in operation in the roof garden. Both units slide through the doorway shown to the right of the speaker. The small opening within this doorway permits the telektor to be moved into the roof tennis court.

In commenting about his radio installation, Mr. Powers said that it was worth at least \$10,000 to him and while the actual installation did not cost this much, it is evident from the description above that this complete radio system cannot be compared with ordinary radio installations.

However, Mr. Powers is not yet satisfied with the installation and has many ideas for improving it. One of these is to use the program machines for other purposes than turning the radio set on and off and awakening him in the morning. He proposes to install a system in the penthouse so that the windows to the sleeping porch will open automatically at 10 P.M. and close at 6 A.M. Also, electric-steam heaters will automatically start at 6 A.M., so that the rooms will be heated when he arises. The electric-steam radiator is contemplated because the building's steam heat is not turned on until later.

## A.C.-D.C. SETS

(Continued from page 279)

this assembly the rest of the box was built, the sides and bottom being screwed on, since it is necessary to drop the bottom in order to unscrew the chassis bolts. The inside dimensions of the box were  $4 \times 4\frac{1}{2} \times 9\frac{3}{4}$  ins., which was ample space. The choke was mounted at about the middle of the cabinet bottom (now the top of the battery box) and the filament ballast resistor cartridge holders on one of the ends.

Before final assembly it is necessary to hook the outfit up temporarily to adjust the tuning condenser trimmers, which is a minor matter, and also to adjust regeneration, which is more difficult.

### Sensitivity Control

Adjusting the regeneration, which determines the sensitivity and, to a considerable extent, the output volume, resolves itself into two jobs, namely: (a) getting rid of incidental or parasitic oscillations; and, (b) re-inserting controlled oscillations.

Incidental oscillations occur at the high-frequency end of the tuning range with the plates of the tuning condenser nearly all the way out. To see if they are present it is of course necessary to cut the regeneration coil entirely out of the circuit. These oscillations are caused by incorrect bypassing, and inadequate isolation of the tuned circuits and the antenna circuit.

An important thing to remember is that the set is to be used finally in a cabinet. In one stage of the experimenting, a set which would not stop oscillating at the high frequency end of the range when the chassis was outside the cabinet and gave good controlled regeneration throughout the range, would not oscillate through more than half the tuning range when it was inserted in the cabinet! Therefore, after each adjustment

the behavior of the set must be observed in the cabinet. Also these tests must be made with the ground connection on, since then the antenna will absorb the same amount of energy as it will in actual use.

The resistor R1 in the grid return of the detector stage is an important item in the final adjustment of oscillations. This is known as a suppressor and serves to isolate the detector grid circuit. Values up to  $\frac{1}{4}$ -meg. may be tried. Too small a value may result in incidental oscillations and too large a value will make regeneration throughout the range impossible. In the particular set tried, about 75,000 ohms proved to be the best value.

The regeneration coil, because of accidental coupling between the plate and grid circuits, will permit controlled oscillations throughout a large part of the tuning range no matter where it is mounted, but in order to obtain oscillations at the low-frequency end it is necessary to have it coupled close to the grid coil of the detector as previously described. Then too it will be necessary to try reversing the leads from it to the potentiometer to make the set regenerate at the low-frequency end.

After these tests are completed fasten the chassis in the cabinet and assemble the battery box. There must be eight holes in the back of the battery box to accommodate the eight battery leads coming down from the chassis. These leads are to be cut as short as convenient. Insert all batteries, making sure to wedge them in with small pieces of wood so that they will not slide around and short to one another.

### "The Proof of the Pudding . . ."

As the set is now, ready for use, its overall dimensions are approximately  $12 \times 12 \times 5$  ins.; it is easy to carry it in an average-size knapsack. Brass chest handles mounted on either side of the cabinet and a belt stretched through them across the top makes a convenient arrangement for lifting the set.

The first test of actual usage was made in a canoe on Deal Lake at Ashbury Park, N. J., where all the New York stations were brought in with good loudspeaker volume.

The set was mounted in the center of the boat and the end of the aerial wire tied to the handle of a canoe paddle jutting into the air from a position forward of the bow seat. At first, a trailer consisting of 25 ft. of bare copper braid with a sinker on the end was used for a ground. This proved hard to handle and continually caught on the bottom of the lake. It was then found that fairly satisfactory reception was obtained with the whole trailer coiled up in the bottom of the boat. Just barely dipping the end of the trailer with the sinker into the water immediately trebled the output, which was now as good as when the trailer was all the way out. Therefore all that is necessary for a "ground" in a boat is four or five feet of wire with a sinker on the end.

In Central Park, New York, a test was made with the aerial wire strung over the limb of a small tree and a counterpoise consisting of about 20 ft. of wire stretched out (in the grass). Because of the absence of steel frameworks the signal intensity was about ten times as great as with a similar arrangement tried on the 12th story of an apartment house located not more than 100 yds. away!

### List of (Additional) Parts

- One resistor, 75,000 ohms, 0.5-W., R1;
- Two resistors, 5 megs., 0.5-W., R2, R4;
- One potentiometer with switch, 20,000 ohms, R3 and Sw.;
- Three ballast resistor cartridges, No. 4V-199, R5, R6, R7;
- Two cartridge condensers, .05-mf., 200 V., C1, C5;
- One mica condenser, 250 muf., C7;
- One mica condenser, 500 muf., C8;
- One RCA detector plate choke (replacement part for Radiolas 44, 46 and 47), 700 by., R.F.C.;
- Three 4-prong sockets with mounting holes on  $1\frac{1}{2}$  in. centers;
- Two type 32 2 V. tubes, V1, V2;
- One type 30 2 V. tube, V3;
- One  $4\frac{1}{2}$  V. "C" battery;
- One 3 V. flashlight battery;
- Two 45 V. "B" batteries;
- One 3 V. "A" battery.

## ANNOUNCING Triplett Fine Instruments ..at remarkably low cost!

IF you choose precision instruments on the basis of their features and performance, you will find that Triplett Instruments are outstanding values. Competitive tests and a point by point analysis prove their superiority. These instruments are advanced in design, rugged in construction, absolutely dependable, give the close readings required for fine work and are popularly priced.

Triplett Electrical Measuring Instruments are made in a complete range of sizes: 2",  $3\frac{1}{2}$ ",  $5\frac{3}{8}$ "—in A.C. and D.C. voltmeters, ammeters, milliammeters, millivoltmeters and D.C. micro-ammeters. Triplett also offers thermo-couple and copper-oxide A.C. Universal instruments and sensitive relays. The D.C. units are equipped with a D'Arsonval moving coil, while the A.C. units are of the double iron repulsion type. Portable, flush and projection panel style cases are furnished.

Here are some of the superior features of these instruments: Sapphire jewels, non-fatigue springs, extra light-moving element, special steel magnet, white metal dials with extra long scales.

### Your Jobber Can Supply You

It will pay you to specify Triplett Fine Instruments. Ask your jobber to show them to you. Write for literature and additional information.

Triplett Electrical Instrument Co.  
16 Main Street Bluffton, Ohio

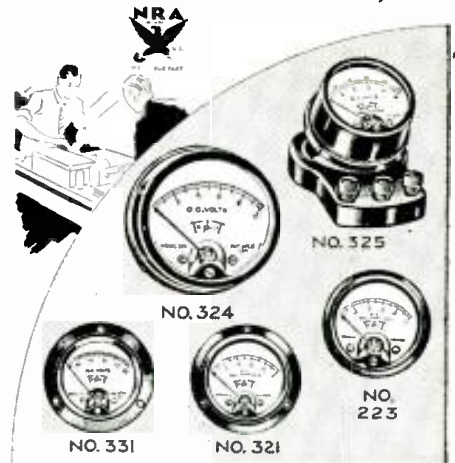

MAIL TODAY FOR DETAILS!

Triplett Electrical Instrument Co.  
16 Main St., Bluffton, Ohio

Gentlemen:—Please send me catalog on Triplett Instruments. I am interested in.....

Name .....

Street Address .....

City .....State .....

**ELECTRICAL BOOKS**  
shipped  
**FREE**

**10 BIG BOOKS**

**A-C-RADIO TELEVISION**  
Every Electrical Subject Covered

Here's great news for anybody interested in Electricity. BRAND NEW 1933 edition of Applied Electricity brought right down to date with every NEW electrical subject fully covered. 10 big Volumes and all shipped FREE for examination.

**FOR BEGINNERS and EXPERTS**  
Over 3000 pages — hundreds of illustrations — the most complete work of its kind ever published. Dynamos, motors, power stations, radi- os, television, everything electrical explained clearly so anyone can understand them.

**BIG FIELD! Big Demand Big Pay!** Men who understand electricity are urgently needed right now in thousands of industries. Autos, airplanes, machine shops—practically every industry depends on electricity and men who know this subject make big money. Pleasant, fascinating work, easy to learn and do; learn quickly with these books. Send coupon for a set for FREE examination and see for yourself.

**FREE** { A year's consulting membership in the American Technical Society now given free to all readers of this famous Cyclopedia of Electricity. Many say, "That's worth more than cost of books." }

**AMERICAN TECHNICAL SOCIETY**  
Dept. E826, Drexel at 58th St., Chicago

**AMERICAN TECHNICAL SOCIETY.**  
Dept. E826, Drexel at 58th St., Chicago  
Send for 10 days' free use, BRAND NEW 10 volume set of Electrical Engineering. In return for mailing this coupon promptly, send absolutely free certificate of membership in the American Technical Society entitling me to free consulting privilege for one year. I will pay the few cents delivery charges on the books. If I wish I may return them in 10 days and owe you nothing, but if I keep them I will send \$2.00 after 10 days; then \$3.00 a month until the special sale price of only \$29.50 is paid.  
Name .....  
Address .....  
City ..... State .....  
Employed by .....  
Address .....

**Try this FORMULA**

WHEN you design or build that new Set Analyzer, Decade Box, Bridge, Ohmmeter or High Resistance Voltmeter why not try this FORMULA:  
 $Q + A + MD = PwWt$

L.C.  
When Q equals QUALITY and A equals ACCURACY MD equals MODERN DESIGN and L.C. equals LOW COST and LAST COST then PwWt is always PRECISION WIRE WOUND RESISTORS.  
RESISTANCE RANGE: .25 Ohm to 1 Megohm

<b>TYPE "F"</b> Normal Rating 1 Watt Maximum Length 1" Maximum Diameter 1/4" Length of Leads 1 1/2" Furnished with No. 18 Tinned Copper Leads.		<b>TYPE "D"</b> Normal Rating 1/2 Watt Maximum Length 3/4" Maximum Diameter 1/8" Length of Leads 1 1/4" Furnished with No. 18 Tinned Copper Leads.
--	---	---

Free Booklets and Price List  
Precision Custom Built Wire Wound Resistors, Mfg. by  
**PRECISION RESISTOR CO.**  
334 Badger Ave. Newark, N. J.

**STEWART-WARNER FACTORY CO-OPERATION FOR SERVICE MEN**

Service meetings to be held all over country by special factory radio field engineers. Complete diagram talk on new Stewart-Warner circuits will show you the easy way to service Stewart-Warner radio sets. Service manuals on all new Home and Auto Sets will be given free.  
For time and place of meeting, write  
Service Department  
**STEWART-WARNER CORP.**  
1826 Diversy Parkway - - Chicago

**SERVICING "TALKIES"**  
(Continued from page 275)

permit him to offer to the theatre, services and benefits which no one else has ever been able to make available at a reasonable cost.

(5) To suggest methods of sales approach to both manager and projectionists, methods suited to their psychology and problems, which will help the radio man to secure an audience, and to lay before those gentlemen, in the most favorable possible light, the superior services and assistance, mentioned above, which he is in a position to render. In this installment current price lists covering theatre parts and services will be furnished, indicating to the radio dealer, just what will constitute fair prices for him to ask.

An outline of the more important factors of the above headings—an outline to be filled in in greater detail in subsequent articles—follows below.

**1. The Nature of Sound Equipment**

Essentially, and stripped of complications of every kind, sound equipment is an audio amplifier. The complications, however, are more important than this simple fact. The input to this amplifier is drawn from three sources. One is an announcing microphone (in some theatres). Another is a phonograph pickup (now seldom used). The third, and by far the most important, is a photoelectric cell. A special lamp shines through the "sound track" at the side of the motion picture film. As the film moves, the amount of illumination that can pass through the film and reach the "P.E." cell changes at audio frequency; the corresponding changes in the cell's electrical output are amplified and supplied to loudspeakers. One complete "frame" of sound film is illustrated in Fig. 2.

The same type of amplifier is used in many theatres, but the number of loudspeakers in any given theatre depends upon its size and shape; therefore the amplifier output is commonly equipped with a tapped transformer or similar arrangement to meet the impedance requirements of any number of loudspeakers.

Theatre amplifiers are commonly larger and heavier in construction than those familiar to the radio man, and for convenience in transportation and in making repairs are often divided into two or more parts, each of which is called an amplifier. Thus there may be as many as four amplifiers in cascade, all, naturally, constituting one large amplifier.

Power supplies vary greatly. Storage batteries and "B" batteries are still used, but are rapidly being replaced by rectifiers, which should prove one fruitful source of income to the radio man. A rectifier installation to replace storage batteries in a sound system will sell for several hundred dollars.

One technical problem of great importance in theatres, but not often troublesome in connection with radio receivers, is that of acoustics. More will be said of this later. At present it is sufficient to note that sound (an air wave) travels at approximately 1,000 feet per second and is reflected by walls or other hard surfaces. At each such reflection, the sound wave loses some of its energy. In the average living room, where walls may perhaps be ten feet apart, sound will undergo a hundred reflections per second and lose all its energy in that length of time. Consequently, echo and reverberation give little trouble in radio installations. But in a theatre, where the walls may be a hundred feet apart, the sound, undergoing only ten reflections per second, may retain its energy and therefore its audibility for two or three seconds or more, confusing new sounds that follow. This condition is known as reverberation and is sometimes very troublesome. Its treatment will be described hereafter.

Another technical problem, somewhat familiar to television enthusiasts, is that of controlling the speed of the motor which drives the sound film. If this speed is not held the frequency of the sound will shift—a form of distortion very annoying to the ear. Several methods are used to control motor speed, some of which include intricate vacuum tube circuits.

**WORLD'S FINEST PHOTO-INSTRUMENT**



In all the World No Other Camera Like This!

The only Quick-Acting, Automatic Winding, Ground Glass Focusing Camera using Standard Roll Film. Good for all purposes. No Separate Parts or Attachments are Necessary!

No Double Exposures with "PAL KO"!  
It THINKS and COUNTS for you. Used by U. S. Government, Educational Experts and Leading Publications. Simple! Positive! Dependable! 3 Cameras in One! "PAL KO" takes full postcard 3A, or 2/3 or 1/3 this size—19 pictures on a six exposure film!  
SAVINGS ON FILMS ALONE WILL SOON PAY FOR "PAL KO"  
SATISFACTORY PERFORMANCE GUARANTEED OR MONEY REFUNDED!  
SOLD DIRECT FROM MANUFACTURER TO YOU  
WRITE TODAY FOR FREE CATALOGUE

**PAL KO, Inc.**  
817 Wash. Blvd. CHICAGO Dept. R-2

Here's a book every Radio Man will refer to dozens of times every day—



**A Valuable RADIO BOOK!**

HERE is one radio book that answers every conceivable question on interference. It contains 76 pages, 8 1/2 x 11 inches, chock full with wiring diagrams, drawings and photographs showing where interference originates—how it is distributed, and how to eliminate it. This is a wealth of information needed by every radio listener, dealer and Service Man. Send fifty cents in stamps or check for this book.

**RADIO-CRAFT MAGAZINE**  
96-98 Park Place New York, N. Y.

**Transformers REWOUND AND REBUILT**

Pembleton's 17 year record in manufacturing transformers assures performance in many cases, even far superior than the original. Each completed job is an achievement of perfection in workmanship, materials and electrical characteristics. Our specialists are trained to repair transformers within 12 hours. Write for free, interesting brochure, "Pembleton's Coil and Transformer Rebuilding Service." Address, Dept. RC, PEMBLETON LABORATORIES, 921 Parkview Avenue, Fort Wayne, Indiana

WRITE FOR NEW CATALOG



## Our Readers Say—

"The RADIO-CRAFT INDEX makes it easy to find the exact location of any article or topic which appeared in RADIO-CRAFT. Without any loss of time, you can locate quickly, the article needed. This book is a big help to every radio man."

# The RADIO-CRAFT INDEX

It contains a thorough, alphabetical and topical arrangement of EVERY article and subject which has been published in all the issues of RADIO-CRAFT from July, 1929 to June, 1932

Radio Men have conclusively proved to us the need and practicability for a book which has included in it, a comprehensive and complete listing of every article which has thus far been published in RADIO-CRAFT. A book which has each topic so sub-divided and cross-indexed that a mere glance at a subject will give you any number of classifications and uses of it. For example, if you look at tubes, you find this topic, various sub-titles, general, power, transmitting, photo-cells, testing of tubes, thyristors, etc. Every article or notice in the book has been considered so deeply important that when you refer to a certain classification, listed below the main topic, you will find perhaps a dozen or more articles treating the subject from different angles. The author in each case is given the exact issue in which the article appeared, and on what page it is to be found. So accurately compiled, by C. W. Palmer, one of radio's foremost writers, that in less than two minutes you can turn to any article—needless to waste through all the issues of RADIO-CRAFT which have been published during the past three years.

The RADIO-CRAFT INDEX is exactly the same size as the monthly magazine—it has 24 pages. It can be conveniently kept on file with the copies of the magazine—ready for quick reference. The index is printed on good paper with self covers.

This book is sold only by the publishers at 25c the copy. Mail coupon below for your copy of the RADIO-CRAFT INDEX.

Briefly outlined below appears only a partial contents of the book

AMPLIFIERS—	PATENTS—
ANTENNA SYSTEMS—	PHONOGRAPH REPRO-
CABINETS—	DUCTION AND RE-
CIRCUITS—	CORDING—
CODE—	POWER SUPPLY AND
COILS AND TUNING—	BATTERIES—
COMPONENTS—	RECEPTION—
COOPERATIVE LABORATORY—	REMOTE CONTROL—
DETECTORS AND RECTIFIERS—	SELLING AND MONEY MAKING SERVICING—
EDUCATION—	SET CONSTRUCTION—
INTERFERENCE AND HUM ELIMINATION—	SPEAKERS AND REPRO-
KINKS—	DUCERS—
MANUFACTURING—	TELEVISION—
METERS AND TESTING EQUIPMENT—	TONE AND VOLUME CONTROL—
MISCELLANEOUS MOTION PICTURE RECORDING AND PROJECTION—	TOOLS—
MUSICAL INSTRUMENTS—	TRANSFORMERS—
NEUTRALIZING—	TRANSMISSION—
NOVELTIES—	TRANSMITTERS—
	TUBES—
	LIST OF BROADCAST SHORTWAVE AND TELEVISION STATIONS—

ABSOLUTELY NOTHING WHICH HAS APPEARED IN RADIO-CRAFT HAS BEEN OMITTED FROM THIS VALUABLE COMPILATION

Clip and Mail Coupon Today!

Publishers of RADIO-CRAFT, RC-11  
96-98 Park Place, New York, N. Y.

Enclosed you will find my remittance of 25c (check, stamps or money order accepted) for which you are to send me, postage prepaid, one copy of the RADIO-CRAFT INDEX.

Name .....

Address .....

City .....

State .....

THIS BOOK CANNOT BE BOUGHT ON THE NEWSSTANDS — ONLY DIRECT FROM THE PUBLISHERS

**25c**  
THE COPY

## 2. The Theatre Manager.

This is the gentleman who guards the portals of theatre business; his signature must approve all purchases or orders for work to be done. But he is a difficult man to approach, being in general quite sophisticated, if not hard boiled. He uses extravagant sales claims in his own business too frequently to be much impressed by anyone trying to sell him anything, however good the offer may sound. He is, however, very keenly on the lookout for every means of cutting his expenses or of insuring his equipment against breakdown. The key to his good graces cannot be discussed now. After the background of his business problems is made plain, the proper method of approaching him will become clear.

## 3. The Projectionist.

The approval of this gentleman is vital. He is officially responsible for the operation and condition of the equipment in the projection booth. Moreover, he is a responsible person in every sense of the word. In many states he is licensed only after a stringent examination. He deals with highly inflammable film, and a moment's carelessness on his part can cost a hundred lives. He will not be pleased with anyone who comes in proposing to show him how to do his work; but the fact remains that he can, in most cases, use the cooperation of the local radio man can supply, and will welcome it if it is offered tactfully. The problem of dealing with him is complicated by the fact that some theatres employ union projectionists, and some men who are not members of any union. Most of the larger and wealthier theatres employ union men, whose salaries in the larger cities run to a hundred dollars a week or more. It is a fact that many of these men learned what they know about electricity in the days before sound came to the theatre and have never acquired an easy familiarity in dealing with vacuum tube equipment. Not that they need help in running their jobs, for which they are paid, but often they can use it, if it is of the right kind, and properly offered. Approaching and dealing with them is a most vital factor in securing theatre business—one that will deserve a full article, devoted to nothing else, and offering many concrete suggestions as to methods of approach.

## 4. The Radio Man's Function in the Theatre.

Why it is that, when the projectionist is capable of making his own repairs the trained man's services will be helpful to him (and can become indispensable) will not be quite clear until after the peculiar nature of theatre business has been discussed, and therefore will be explained more fully. At this point the radio reader may, if he will, accept the statement that he can be of most vital service, as a fact, subject to later elaboration. The crucial point is that merely to repair theatre equipment is not enough; it must be repaired, when it breaks down, in a great hurry. The radio technician offers the theatre his experience, his meters, his stock of parts, and his instant availability as a resident of the community. In most instances no one but himself can give the theatre all these advantages.

## 5. Sales Approach.

That the sales approach to the theatre must be tactful and not clumsy; that it should not be undertaken on the spur of the moment but carefully engineered with a full knowledge of all the details of the sales resistance that normally will be encountered, should be sufficiently plain from the foregoing. Concrete suggestions will follow.

### Theatre Problems Are Interlocked

It will be seen from the above that many of the problems a radio technician may expect to encounter in seeking theatre business interlock with each other; therefore it was thought well to preface a detailed discussion of each with this general outline. When the subjects described above are taken singly in greater detail, reference to this outline

Get . .

# FREE

service

# BULLETINS!

Keep up-to-date on new facts and methods discovered every month by other service men.

"Sylvania News" brings all the latest news of radio sets and servicing. In every issue, there's a full page of useful servicing tips from other men in your business. Fill in and mail the coupon and you'll get this valuable service FREE each month. No obligation . . it's a complimentary service offered by the makers of Sylvania Tubes.

And here's a chance to cash in on your experience, too! Send in your own servicing tips. For every one that's printed in "Sylvania News," you get a free Sylvania Tube (any type you select up to \$3.00 in value!)

# Sylvania

THE SET-TESTED RADIO TUBE

A PRODUCT OF HYGRADE SYLVANIA CORPORATION



## MAIL COUPON TODAY!

Hygrade Sylvania Corp. A-4  
Emporium, Pa.

Dear Sirs:

Please put my name on the mailing list for your free radio bulletin, "Sylvania News."

Name .....

Address .....

City .....State .....

**It's Free!**



**Just Off the PRESS**

**Catalog of 10,000**

**RADIO BARGAINS!**

You can't get along without this great Radio Bargain Book! More than 10,000 items are listed! Anything and everything that you might ever need is here! SETS, TUBES, SPEAKERS, REPLACEMENT PARTS, KITS, etc. Every latest development! Every innovation at lowest wholesale prices!

No matter what you want we have it. We have the largest stock of replacement parts in the world—replacement parts for every known radio set! Save time and money by bringing your requirements to WHOLESALE RADIO SERVICE COMPANY first!

**SHORT WAVE FANS!**  
If you're interested in Short Waves, be sure to get this great catalog. It lists hundreds of Bargains in Sets, Converters, Coils and Equipment. Prominent makes such as NATIONAL, HAM-MARLEND, LAMAYETTE, etc. are featured!

Buy from this 12 year old concern—the HOUSE OF RADIO RELIABILITY—where your satisfaction is guaranteed!  
**NO CONNECTION WHATSOEVER WITH ANY OTHER COMPANY!**

**Wholesale Radio Service Co., Inc.**  
100 Sixth Avenue, New York, N.Y.

Dept. C-113

Rush your Big New Catalog to me at once.

Name .....

Address .....

City ..... State.....

**Truly Remarkable Reception With the DUMONT Aerial and Static Eliminator!**



Illustration shows eliminator with leads and plug attachments.

Here at last is a device made to eliminate completely man-made static, the type of noises that so often causes discomfort to radio listeners. Quickly it reduces it to a minimum, disturbances caused by electrical appliances and aerials of all descriptions, and brings in reception with clear, and excellent results. Can be connected in five minutes. Eliminates all roof aerials.

Service Men and Dealers add this money-making radio device to your line—install the Dumont Eliminator in every home where you call to service the set. A lifetime of service is guaranteed for every Dumont Eliminator.

**Clip Coupon and Mail**

**DUMONT ELECTRIC COMPANY, Inc., RC 453 Broome Street, New York, N. Y.**

Enclosed you will find check or money order for the amount of \$2.85 (Regular List Price \$5.00), for which send me, prepaid one Dumont Static Eliminator, with complete operating instructions.

Name .....

Address .....

City ..... State.....

Read the announcement on page 293 about the new OFFICIAL AUTO-RADIO SERVICE MANUAL. This is the greatest book of the year for Radio Service Men.

should indicate how each of them relates to the others, and so make for more thorough understanding. But before any of them can be taken up fully it will also be necessary for the reader to have some conception of that extraordinary nature of show business, which underlies them all.

Just as no one of the above subjects can be made clear without some reference to one or more of the others, so none of them, not even the technical nature of the apparatus, can adequately be grasped without constant reference to the unusual problems of the theatre industry. The special nature of that industry is described below, and should always be remembered through everything that follows. The high prices paid by theatres for projection room supplies and labor, the psychology of the theatre manager as a business man, and many other peculiarities the radio reader will find mentioned in the articles to follow, and will encounter in practical contact with his local theatres, are all explained by the fact that the amusement business is drastically different from any other business whatsoever.

The butcher, baker and radio dealer all sell tangible, concrete merchandise, that can be carried away, that can be weighed, measured, examined. The theatre's customers carry nothing away from its doors, unless they carry it in their heads. The theatre does not sell even its seats. It rents them for the time being; time is what it sells, and what it gives in return for the money it takes is a *mood*—a very difficult thing for the customer to weigh, measure or examine. How can the customer ever tell that he is getting his money's worth? So many little things prevent him from getting it.

A man may easily buy his admission and enter the theatre in a state of mind that prevents him from enjoying the show. The state of mind in which a man enters a radio store doesn't matter quite so much. If he buys a tube, at least he comes out with the tube. But if he buys theatre entertainment while he is in the wrong mood to enjoy it, he comes out with nothing and holds a grudge against the theatre. Therefore the manager, unlike most other business men, must cajole his customers before they become his customers; must dress up his front with lights, and attractive pictures, put uniforms on his cashier and doorman, decorate his vestibule called the lobby, and do many other things not thought of by other business men.

Once the customer is inside no small annoyance may be permitted. In the wealthier theatres, the lighting, the carpets, the seats, the drinking fountains, the rest rooms, the very tone of voice of the ushers, are given the minutest attention—thousands of dollars are spent on what seem, to one not in the business, to be the merest trifles. The theatre is in business to make money, not to throw it away, but even a small annoyance may upset the patron's enjoyment of that intangible, unmeasurable thing called entertainment, for which he has paid his money, and then he is less likely to come back. A large proportion of movie patrons are women, and the ladies, as everyone knows, are sometimes very fussy about very small trifles, and badly upset by them.

The moral of the above is that: a slight distortion in the sound is a crime; a distracting noise in the sound is a sin; and interruption of the show is high treason! A theatre will go to great lengths, and spend large sums, to avoid any of those things.

That fact will be clearer when it is realized that theatre business, like the baker's and unlike the radio man's, is essentially repeat business—the vital problem is "to make them come back." But, differing from the baker-shop, the theatre does not purvey a necessity. The problem of the baker is to insure that his customers will return to him, instead of going to some other bakery. The problem of the theatre industry is to make customers come to the theatre at all. This is one of the reasons why, in theatre code, a distracting noise in the sound is a sin, and interruption in the show unpardonable. It is also one of the reasons why advertising is of the most vital importance to show business, and why you will find the manager, when you go to see him, much more interested in the

**A Revelation IN Short Waves - "Cooking By Short Waves"**

Complete Details in the November issue of **SHORT WAVE CRAFT**

FOR 25c A COPY



At All Large Newsstands

4-Color Cover 9"x12" in Size Over 200 Illustrations

**RAPIDLY** increasing each day are the number of experiments in the Short-Wave field—developments which are bringing to this branch of radio thousands of new "thrill seekers." Experimenters, as in the early days of radio, again have the opportunity of trying about stirring new inventions. Read in **SHORT WAVE CRAFT**, the *Experimenter's Magazine*, how you can build your own Short-Wave Sets, both transmitters and receivers. **SHORT WAVE CRAFT** is exclusively a short-wave magazine—the kind you have wished for so long.

**Feature Articles in the November Issue**

- Cooking With Short Waves.**
- The Short Wave Scouts**—handsome trophy cup given monthly—by Hugo Gernsback.
- Ham and Yeggs**, by W. H. Fraser—Short-Wave Fiction.
- Adding Phone To The Amateur Transmitter**—With full details and diagrams, by Leonard Victor, W2DHN.
- World's Tiniest Radio Tube.**
- A 4-Tube "5 and 10" Meter Receiver**—with Optional Super Regeneration! By George Shuart, W2AMN.
- The Best Short Wave Station List in Each Issue.**

**SPECIAL OFFER COUPON**

**SHORT WAVE CRAFT** RC-11  
98 Park Place, New York, N. Y.

**GET ACQUAINTED OFFER**

I enclose \$1.00 for which enter my subscription to **SHORT WAVE CRAFT** for 8 months. (I understand that your regular rate for a year's subscription is \$2.50.) I will mail me a sample copy of **SHORT WAVE CRAFT** for which I enclose 15c U. S. Stamps or coin accepted.

Name .....

Address .....

City ..... State.....

**REFRIGERATORS!**  
**SERVICE ELECTRIC**  
**Refrigerators!**  
 In your community there are dozens of electric refrigerators to be serviced. Many need immediate repairs which can be made quickly, with little expense—and which you can repair with the aid of this authoritative Refrigeration Service Manual. Make many extra dollars, together with other repair work. Electric refrigeration servicing is a well-paying business—start in your spare time—before long you will devote full time to it. One or two jobs pays the small cost of the OFFICIAL REFRIGERATION SERVICE MANUAL.

**96 Pages of New Data  
 Have Been Added to the  
 OFFICIAL REFRIGERATION  
 SERVICE MANUAL**

To bring this useful service manual right up-to-date, Mr. L. K. Wright, the editor of the OFFICIAL REFRIGERATION SERVICE MANUAL, has added a wealth of material on new electric refrigerators, and older models as well. As usual every refrigerator has been accurately described from the viewpoint of servicing—diagrams to illustrate the essential parts, so simplified that repairs can easily be made. The addition of these new pages will not increase the cost of the book to those who order their copy now.

**Here Are Some of The Important Chapters:**  
 Introduction to the Refrigeration Servicing Business  
 History of Refrigeration  
 Fundamentals of Refrigeration  
 Description of All Known Types of Refrigeration Motors  
 Trouble Shooting  
 Light Parts, Valves and Automatic Equipment  
 Makes and Specifications of Units  
 Manufacturers of Cabinets  
 Refrigerants and Automatic Equipment and Many Other Important Chapters



**Over 1,200 Diagrams  
 450 Pages  
 Flexible Looseleaf Binder  
 Complete Service Data**

**Mail Coupon Today!**

GERNSBACK PUBLICATIONS, Inc. RCH-11  
 95-98 Park Place, New York, N. Y.

I enclose herewith my remittance for \$3.00 (check, stamps or Money Order accepted) for which you are to send me, postage prepaid, one copy of the OFFICIAL REFRIGERATION SERVICE MANUAL, together with the extra 96 pages of new material at no extra cost.

Name \_\_\_\_\_  
 Address \_\_\_\_\_  
 City \_\_\_\_\_ State \_\_\_\_\_

colored pictures he expects to dress his lobby with for the next show than in anything you can say about saving him money in the projection room. It is also the reason why you have a very good chance to sell him an amplifier and loudspeaker to use outside his front door for advertising purposes.

**High Treason—and Worse!**

Theatre people say: "The show must go on"—and they mean it. The show *must* go on—one excellent reason is that if it doesn't the audience asks for its money back. Now, this is more expensive in show business than in any other. Because—if a dissatisfied customer brings back a radio receiver, and asks for his money, the radio store loses a sale;—that's bad enough, but at least it gets the receiver back, and can sell it some other time. But when the theatre gives refunds to its patrons because the show has stopped, it gets nothing back, for the theatre does not sell seats, but "time," and rents the seats for the time involved in one show. The next show is a new show, with new seats, or rather new time, to be sold. Time is the theatre's stock in trade, and it cannot be taken back when the customer is given his money back; the theatre that has to refund admissions is in precisely the condition of a radio store that had to refund the price of a defective radio receiver—if the customer kept both the radio set and his money. It has lost part of its stock in trade without any return. Therefore—the show **MUST** go on. And whatever money must be spent in the projection room to see that it goes on, must be spent—if rules cost \$50 apiece, that's just too bad; it's a lot cheaper to keep spares than to have a breakdown.

In these recent years of depression not all theatres have done as much as they usually do to avoid slight distractions to the patron; not all of them have done as much as they usually do to insure against interruption of the entertainment; but the above describes the normal condition of theatre operation in the United States, and a condition that has been fairly well approximated even in these hardest times. The chief difference the depression has made is that formerly the manager was so interested in his advertising that he ordered what he was told was the best for his projection room, and didn't care greatly if it cost a bit too much. Now he has formed the habit of being extraordinarily keen to save any slight operating cost he can—but not at the expense of patron annoyance or—above all—of a stop in his show.

**CARBON MICROPHONES**

(Continued from page 287)

ment determining optimum stretch, "cut and try" is the best method.

The carbon cups, II and I are filled *half full* of carbon grains, the grade dependent on the use to which it is to be put. Number 60 is recommended for hard usage; No. 80 is used for general work and is selected in most instances; No. 100 is best for extremely high quality reproduction. The latter packs quite easily and has a slightly higher background noise; and is suitable for use where the microphone is thoroughly protected from bumps and vibration.

Figure 2 shows the procedure in filling the button cups. A flat piece of glass is held vertically, across the front of the button and the button tapped lightly to settle the carbon. The amount of grains can be viewed and the same amount put in each one. If the pressure of the button felts on the diaphragm is equal, the buttons will be balanced, electrically.

The damping plate (F, in Fig. 1) is spaced from one to two thousandths of an inch from the diaphragm. If several grains of carbon or dust are permitted to remain on this, it is obvious that they will touch the diaphragm and damp the movement. The damping plate should be cleaned immediately before assembling.

The buttons are replaced and the microphone is again ready for an over-enthusiastic political speaker, an excited orchestra leader or a bouncing sound truck to start it on its downward path.

**SERVICE PROFITS  
 ASSURED**

WITH THE  
**RCA RADIOTRON  
 CUNNINGHAM RADIO TUBE  
 SERVICE SYSTEM**



**SERVICE ORDER FORM**  
 (Similar Form for Cunningham)

The Service Order Form is one of the most popular features of the RCA Radiotron-Cunningham Service System, comprising also a Prospect, Sales and Service Record Form, Service Billhead, Not-at-Home Card, Service Post Cards, Service Advertising Mats and numerous other profit-building items.

Thousands of dealers and service men are making money on service, right this minute, with the aid of the Service Order Form.

This form offers the service man a simple, complete, accurate method of making charges and recording service work done.

Its very completeness stimulates the service man to do a thorough job. Space for "complaint" is a time saver because as many facts as possible are ascertained in advance.

Complete customer information is compressed into one line with the use of symbols.

50 triplicate sets to a pad. Radiotron Item No. 319. Cunningham Form No. 1180. Price, imprinted, with six sheets of carbon paper, 3 pads for \$1.25.

PROMOTION DEPT., R. C.  
 RCA, Camden, N. J.  
 I enclose \$1.25 (cash) (check) (money order). Send me 1 set of Service Order Forms (3 pads).  
 Dealer  RCA Radiotron  
 Service Man  Cunningham  
 Name.....  
 Street.....  
 City..... State.....

"Best for Every Test"  
New Model 401

## MULTITESTER

A Leader in Design—A Champion in Performance—A Winner in Price!



PRICE ONLY  
**\$15.00**  
NET

Knock-Down  
KIT

(less batteries)  
Complete with  
Instructions  
Net to Dealers  
and Servicemen  
List \$27.50

The MULTITESTER leads because it will never become obsolete. It excels in Performance because it functions more accurately, quicker and better than other testers. Nevertheless, the price is lower than that of ordinary testers.

This high-quality instrument includes a Triple Range Ohmmeter, 1/2 to 2 million ohms, completely self-contained; a Four Range Voltmeter, 0-5-50-250-750 volts, at 1000 ohms per volt; a Triple Range Milliammeter, 0-5-250-750 mills.

An Automatic Selector Switch instantly connects to the desired circuit and range, at the same time disconnecting the meter from all other circuits and ranges. This safety feature prevents short circuits and burn-outs. The meter employed is a 3 3/4" D'Arsonval type moving coil instrument. Accuracy within 2 percent. A tapered compensator gives smooth zero adjustment on all ohmmeter ranges.

The Multitester is mounted in an attractive, compact, crystalline finish case—3 3/4" x 8 3/4" x 4 1/2". Panel is clearly etched. A set of high-grade test leads with detachable alligator spring clamps included with Multimeter. Assembled, wired and ready to use \$20 net to dealers and servicemen. List \$37.50.

### THE "DEPENDABLE" TUBE TESTER NEW MODEL 303A

Will Always Be Up-to-Date

Certainly it tests every new tube—more than 130 different types are indicated on the panel. Furthermore, it provides for testing 50 more new type tubes. Perpetually up-to-date, it has many other features. See high-quality D'Arsonval moving coil meter. Tests all tubes more accurately and scientifically. Only two selector switches to adjust. Has short tester, moulded sockets including large and small 7-iron sockets, pilot light indicator, gas test, second plate for all test-tubes, line voltage adjustment, beautifully etched panel, light compact, good-looking leatherette carrying case.

**\$18.75** net to dealers and servicemen—List \$35  
Also available in Knock-Down Kit Form Complete with Instructions **\$14.75**

Send for free data sheets on complete line of test equipment.

### RADIO CITY PRODUCTS CO.

48 West Broadway Dept. RC New York, N. Y.

## SOLVED !!

For those Amateurs or Short Wave Fans who couldn't afford a real commercial S.W. Receiver, Postal is now offering the International Professional. A powerful and selective, laboratory built 9 tube A.C. Short wave super-heterodyne. It employs a tuned R.F. stage, instantaneous band spread, new drawer type coils, audio C.W. sec., electron coupled osc., 3 watt output and other professional features. Dependable world wide reception. Kit or laboratory wired. Described in November Radio News and October Short Wave Craft.



Write immediately for diagram description and special offer to Radio Craft Readers.

POSTAL RADIO

135K LIBERTY ST.  
NEW YORK, N. Y.

### TAUREX Meter Rectifier

Converts any D.C. Milliammeter into a Sensitive A.C. Meter MADE FOR METERS—Size 1/2 in. by 3/8 in. FULLY GUARANTEED.

Can be used in Set Testers, Analyzers and for many other purposes. See article on Universal Analyzer in Oct. issue of Radio-Craft. TAUREX will be shipped postpaid promptly upon receipt of \$3 (check or money-order—or order C.O.D.) and pay postman. Furnished complete with Diagrams and Instructions.

The Taussig MASTERDIAL—installed on your 0 to 1 D.C. Milliammeter enables you to read Sixteen A.C. and D.C. Voltage, Resistance and Capacity Ranges. Price \$2.75 postpaid.  
Leo Taussig, 3245 37th St., Long Island City, N.Y.

## MAKING CHOKES, ETC.

(Continued from page 281)

the layer and continue the winding operation.

### Tapping the Transformer

It is much easier in taking taps off the windings to take them off at the outside turn rather than to bring them from within the winding, and by juggling the number of layers and the turns per layer this can usually be accomplished, if the number of taps needed is not too great. This will, of course, have to be planned out before the construction begins. If it is found necessary to bring out taps within the coil, great care should be taken not to weaken the insulation. The turn to be tapped should be pulled up slightly and a strip of empire cloth placed under the spot where the lead is to be soldered on. The lead running out of the coil should be insulated with cambrie tubing and have strips of empire cloth on each side. When the primary winding has been completed, bind the last turn in much the same manner as before; use a longer piece of tape for doubling back, and a strip of adhesive to hold it in place until the secondary binds it. Place one or two layers of empire cloth around the winding and fasten it by a small strip of tape around each side. If a static shield is desired it can be made of a very thin sheet of copper about 1/2-in. wider than the winding and cut to a length such that it lacks approximately 1/4-in. of going clear around the primary. This can be held in place while one or two layers of empire cloth are wrapped over it and fastened in place with as little tape as necessary. Everything is now in readiness to start winding the secondary which is constructed the same as the primary.

When the winding is finished and bound completely, wrap the entire coil with cotton tape, the wrapping being done perpendicular to the wire. The coil is then immersed in a hot mixture of beeswax and resin and slowly boiled for fifteen minutes. The coil is again completely wrapped, this time with either friction or empire tape. Build the core up as shown in Fig. 1, if stamped laminations of this type are used, and slip pieces of paraffined cardboard between the coil and the core. The coil can be tightened onto the core by carefully driving very narrow wedges, from each side of the transformer, between the core and the cardboard. The core should be very tightly clamped to prevent excessive vibration; angle irons or bolts are suitable for this purpose.

### Mounting the Transformer

One of the easiest and most effective methods for mounting such a unit is to place it in a can similar to the type shown in Fig. A.

After the transformer is placed in the can, the can should be filled with hot asphaltum or resin compound to seal the unit. The following table, 1, of average design factors, gives the desirable set-up for use in building ordinary transformers of conservative rating, although the values can be varied up to ten per cent, and still be within working limits. It is advisable to use single-cotton, enameled wire for this class of work as it has high insulating qualities and cannot be damaged as easily as plain enameled or plain double-cotton-covered wire.

TABLE 1 (Average Design Factors)

Rating Watts	Core, Sq. In. N.-Section	Wire Size Prl.	Turns Prl. or Sec.	Turns/Volt
50	2.0 Sq. In.	23	500	4.55
75	2.2 " "	21	425	3.87
100	2.4 " "	20	350	3.18
150	2.7 " "	18	310	2.86
200	3.3 " "	16	265	2.52
300	4.0 " "	14	245	2.23
400	4.4 " "	13	190	1.75
600	5.5 " "	11	135	1.23
800	6.0 " "	10	120	1.09
1000	7.3 " "	9	110	1.00

Although different transformers will require slightly varying methods of construction, by exerting care and discretion, highly satisfactory transformers will result.

The next article will cover A.F. transformers.)



## A Symbol

THE Yule log—symbol of Christmas through the ages. On the great holiday the lord of the manor threw wide the doors, and misery and squalor were forgotten in the cheer of the boar's head and was-sail.

Customs change, but the Christmas spirit is ageless. Today millions express it by the purchase of Christmas Seals—the penny stickers that fight tuberculosis—still the greatest public health problem. Your pennies will help.



BUY CHRISTMAS SEALS



AMERICAN  
RED CROSS

## SEXOLOGY

THE MAGAZINE OF SEX SCIENCE

SEXOLOGY, foremost educational sex magazine, is written in simple language and can be read by every member of the family. It is instructive, enlightening—not a risqué book—contains no jargon. Devoted to Science of Health Hygiene.

Contains 25 important articles on Sex Science, 68 pages, with attractive two-color cover. Here are a few of the more important articles: Pregnant men; Suckle Infants; Circumcision of Women; Men Who Struggle in Church and Sexual Education; Menstruation in Monkeys; the Birth of Stone Babies; Sex Crimes; A Boy or a Girl? Sexual Selection; Control of Syphilis; Sexual Deficiencies; Impotency in Young Men; White Man Turns Negro, etc. Get a copy of SEXOLOGY on any newsstand, or, if your dealer cannot supply you, send 25c in stamps for a copy of the current issue.

SEXOLOGY 25R West Broadway New York, N. Y.

Read the announcement on page 260 about the new 1934 OFFICIAL RADIO SERVICE MANUAL. This is the greatest book of the year for Radio Service Men.

## A 26-W. "INTER-LOCKING" P.A. SYSTEM

(Continued from page 283)

the speaker field. Therefore, it is recommended that the separate external speaker field exciter, shown in Fig. 1, be employed.

This unit as shown at B in Fig. 8 is composed of a heavy-duty power transformer, PT3, arranged in a full-wave rectifying circuit employing a type 83 mercury vapor rectifier V10 (which produces sufficient current to fully energize two 6,000 ohm field coils), together with a 15 hy., 200 ohm, 120 ma. choke coil, Ch10, and an 8 mf., 500 V., dry electrolytic condenser, C21. The latter two units remove all audible filter ripple from the speaker fields. Flush-mount female receptacles RC3 and RC4 provide for convenient connection of the two speaker fields to the exciter.

By using this special field exciter the versatility of the system is vastly increased. It provides for the use of an additional speaker at any future time (if the initial purchase includes only one) without making any changes, and also simplifies the installation of either one or two speakers at any distance from the amplifier, since only the voice-coil connections need be run from the amplifier to the speaker, while the 110 V., A.C. connections for the exciter may be taken from any A.C. outlet adjacent to the speaker.

(The manner in which the accessories are connected to one another is illustrated in the block diagram, Fig. 9.)

It should be borne in mind that one of these exciters is required for every two speakers; thus, if four or eight dynamic speakers are employed, then two or four exciters respectively, must be used. Figure J shows how both the speaker exciter and phono, turntable power supply are temporarily mounted in the cover of the speaker case. Both units are readily demountable for use at remote points.

In conclusion, the writer expresses the hope that this unique and highly versatile P.A. System will be the means whereby radio dealers and Service Men will considerably increase their incomes, either by entering, or by branching into the highly profitable "industry" of renting or selling P.A. amplifiers. The author will be pleased to answer any queries that RADIO-CRAFT readers may address to his attention.

### List of Parts

- Input mixer control box  
 One Remington double-button microphone transformer, type E670, T1;  
 One Remington phono, pickup transformer, type E670, T2;  
 Two Electrad rheostats, 400 ohms, R1, R2;  
 Two Electrad modified "T" type attenuators, 0.5-meg., R3, R4;  
 Two D.P.D.T. toggle switches, Sw. 1, Sw. 2;  
 One S.P.S.T. toggle switch, Sw. 3;  
 One S.P.D.T. toggle switch, Sw. 4;  
 One Remington tone control, TC;  
 One Readrite milliammeter, 0-25 ma., M2;  
 One 3-way polarized plug and outlet, PP1, PP2;  
 One Coast-to-Coast drilled chassis; Misc. hardware assortment.  
 Phono. Motor Power Supply  
 One Remington power transformer, type E670, PT2;  
 One electrolytic condenser, 2,000 mf., C27;  
 Two copper-oxide rectifiers, type NB-16, RE1, RE2;  
 Two flush-mount female receptacles, RC1, RC2;  
 One S.P.S.T. "on-off" switch, Sw. 5;  
 One fuse, 2 A., F2;  
 One Coast-to-Coast drilled chassis; Misc. hardware assortment.  
 Speaker Field Coil Exciter  
 One Remington power transformer, type E670, PT3;  
 One Remington filter choke, type E670, Ch10;  
 One 8 mf. electrolytic condenser, C26;  
 Two female flush-mount receptacles, RC3, RC4;  
 One 20 ohm C.T. resistor, R20;  
 One S.P.S.T. toggle switch, Sw. 6;  
 One fuse, 2 A., F3;  
 One Coast-to-Coast drilled chassis; Misc. hardware assortment.

## A Tip for SERVICE MEN

THE name "ELECTRAD" on a replacement Resistor, Volume Control or Amplifier has always meant the HIGHEST QUALITY at the LOWEST POSSIBLE PRICE. ELECTRAD products were the best obtainable when radio was young, and they are the best today—the result of pioneering and specialization.

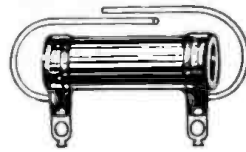

Ten  
Watts  
of

### RESISTOR PERFECTION

Here is a wire-wound, vitreous-enamelled ten-watt that is compact, beautifully made, long-lived and remains constant in resistance value. The price is so low there is no longer any excuse for using non-wire-wound resistors of low wattage, when you can have the extra safety factor without extra cost. The electrical industry has recognized vitreous enameling as the finest type of insulation for more than fifty years. Monel Metal contact bands and lugs resist oxidation and eliminate expansion strains. Equipped also with pigtails. Some type made in three sizes, three wattings and 67 values.

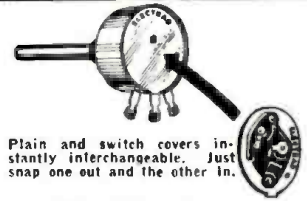

Plain and switch covers instantly interchangeable. Just snap one out and the other in.

### The Handiest VOLUME CONTROL

Without disturbing control connections, ELECTRAD Replacement Volume Controls may be converted to the power-switch type merely by removing the standard end-cover and snapping the switch assembly in its place. Long, ALUMINUM shafts are easily cut to desired length. Just five types required to service 799 standard model receivers.



### VEST-POCKET VOLUME CONTROL GUIDE

FREE

Write for FREE Copy



Write Dept. RC-11 for  
FREE GENERAL CATALOG  
and VEST-POCKET  
VOLUME CONTROL  
GUIDE.

175 Varick St., New York, N.Y.  
**ELECTRAD**

## The Source of Supply FOR AMPLIFYING EQUIPMENT



### WANT IT?

Complete Webster catalog showing latest types of amplifiers and other sound equipment, sent on request.

Here you can get everything from the small Portable Public Address outfits to large Rack and Panel combinations for theatres, auditoriums and schools. All types, sizes and prices of units for indoor and outdoor fixed or movable installations—many of them carried regularly in stock ready for immediate delivery.

Mixing Panels, Transformers, Booster Devices, Centralized control assemblies, Radio and Phonograph, Screen Grid Audio, Pentode Amplifiers and special equipment built to order. Back of every unit in this wide, well balanced line is the Webster laboratory and the Webster guarantee. Webster equipment and statements are dependable.

Inquiries and requests for quotations invited.

## THE WEBSTER COMPANY

CHICAGO, ILLINOIS

### BACK ISSUES OF RADIO-CRAFT

which you might need to complete your files, can still be had at the price of 25c per copy. Send us your requirements, together with your remittance in check or money order.

RADIO-CRAFT

98 PARK PLACE

New York, N. Y.

You'll find this the  
**GREATEST VALUE IN MIKES**  
...or your money back!

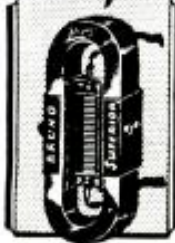

The BRUNO SUPERIOR VELOCITY MIKE is "so superior to the average microphone used by amateurs that there is no comparison," says a well-known radio expert. Excellent for public address or studio. Rapidly replacing carbon mikes. Voices come thru life-like. Says Mississippi, not "Mith-yippi". Response 30 to 14,000 cycles. List Price (Kit) \$10.00

**BETTER RECEPTION WITH THE AMPERITE**



The only automatic voltage regulator. Keeps set at the required voltage. Prevents overloading and untimely burnouts.

AMPERITE Corporation 561 BROADWAY NEW YORK

**FINAL BIG CLOSEOUT OF JEWELL TUBE CHECKERS**

Jewell 538 tube checker. This is the one that every dealer wants. Now you can afford to buy two or more at this special price. Only 25 left. Each set furnished with the No. A-1 d. XL single adapter. Our price



\$29.75

2A3	112A	33	42	57	81
2A5	120	34	44	58	82
5Z3	22	35	45	59	83
15	24A	36	46	71A	84
19	24	37	47	72	85
01A	27	38	48	73	86
1	30	39	50	74	87
1D	31	40	51	80	
WD12	32	41	56		



MAIL ORDERS FULLY GUARANTEED. SAME DAY. C. O. D. Orders must be accompanied by 10% deposit. Include postage. 45D Vesey Street NEW YORK, N. Y.

N. Y. Headquarters for Transmitting Apparatus

**HIGH-FREQUENCY LOUD SPEAKER**



Efficient, precision-built dynamic unit to cover audio band from 3000 to 12,000 cycles. Specially designed horn included with unit. Perfect for wide-range reproduction. Can be used with large horn or cone speakers and filter listed below.

List \$25.00

Special high and low-pass filter with coupling transformer. for amplifier output. Cast aluminum case and coupling transformer.

List \$25.00

Write Dept. RC-11 for Data

**RACON ELECTRIC CO., Inc.**  
52 East 19th Street, New York, N. Y.

**SUPER TESTING KIT! WITH PENCIL TYPE HANDLES**



and interchangeable Tip End. Kit complete with 2 Plug-In Probs, 2 Alligator Clips, 2 Needle Point Probe Tips, and 2 Spade Lugs. Long, Thin Pencil-Type handles for easy testing in tight places. Ideal for testing Long and Short-wave Sets, Coils, Condensers, Etc. Complete Kit. Introductory Price Now \$1.00 Prepaid. American Radio Hardware Co. 137 Grand Street New York N. Y. Write for Free Parts Catalog

**CAR-RADIO NOISE**

(Continued from page 288)

Internal pickup, battery lead, remote control lead, etc. This should be minimized before anything is done about connecting or locating the antenna. Shunt one of the "spare" condensers from the key side of the ignition coil to ground. Likewise try a connection from the gas indicator side; also, the battery side of the coil, if it is a three-contact coil. Do not try to connect a condenser from the midpoint of the coil to ground because, besides getting a nasty "shot in the arm," you will "kill the motor," since high-tension current goes through a small condenser like sand through a sieve, and a puncture is liable to happen to the low-pressure condensers used for the purpose. Bypassing one or more of the points mentioned should bring the noise down decidedly.

If the ignition coil is mounted under the dash-board, on the set side of the bulkhead, it is best not to waste time but to remove the coil and place it in the motor compartment, as near to the distributor as possible. It sometimes happens when the switch is an integral part of the coil, that when the coil is removed it will be necessary to obtain a separate switch and put it on the dash; then, lock the original key in the coil and solder it in place in the locked position. Bring the leads from the new key to the coil by using ordinary, heavy-duty twisted lamp cord, first sheathing it in copper shielding.

Connect up the coil, close the hood and, using a coil of fifteen or twenty feet of insulated wire connected to the antenna lead and thrown on the ground outside the car, tune in a station and note the noise level with the motor running. Unless the car is a Buick or a similar car which has everything practically inside the motor block, it is to be expected that noise will be heard, but it should be decreased to some extent.

**"Trimming the Rotor"**

The next procedure is "trimming the rotor" of the distributor. Remove the cap on the distributor head and take out the rotor (that little gadget which goes round and round and actually distributes the "kick"). Lightly dress down the running-edge with a file to remove the corrosion from the firing side, and then carefully build it up with hard solder as shown in Fig. 1B so that it makes an actual wiping contact with the spark plug point contacts. Some cars use a rotor which makes an actual wiping contact by means of a spring slider. In this case simply dress up the cap contacts and rotor with very fine emery cloth or, preferably sandpaper, until shiny.

In the case of fixing the rotor, it need not be stated to use extreme care, because if a slight amount too much solder or a sloppy job of soldering is done on the point there is a very great chance of the distributor cap being split the first time the motor is started up. A few tests will generally show how much to use in each individual case. It is better to make several tries each time, adding a little until it just makes a light contact, than it is to spend time and money buying your customer a new cap for his distributor.

The placing of the "A" battery lead can also cause a goodly amount of pickup. Try all three suitable places for the least amount of "back up" namely the positive "A" of the battery, the starter positive and the ammeter positive. When the best place is found, make that lead as short as it is possible. The writer has found cases where a healthy-size R.F. choke properly bypassed to ground helped immensely. For this purpose a simple choke is made up from annunciator wire wound on a suitable form. From 1/4 to 1/2 pound of No. 14 is sufficient.

With all these tests made, install the antenna which is to be used, and again compare the reception with that when the outside wire was being used. If the noise level goes up it means that your aerial is either inefficient or insufficient. If you are using the antenna supplied with the car, in the roof of the tonneau, try supplementing it with an under-car aerial; also try using just an under-car aerial alone, not using the car aerial at all. With due respect to the manufacturer

**CLASSIFIED ADVERTISEMENTS**

Advertisements in this section are inserted at the cost of twelve cents per word for each insertion—name, initials and address each count as one word. Cash should accompany all classified advertisements unless placed by a recognized advertising agency. No less than ten words are accepted. Advertising for the December 1933 issue should be received not later than October 9th.

**AUTO GENERATORS**

A.C. AUTO GENERATOR—Convert Ford generator into 110-volt, 250-watt, dependable A.C. generator. Driven by fan belt on car. Adaptable for public address, radios and home, camp or flood lighting. Simple instructions with complete drawings. Only \$1. Autopower, 410 So. Hoyne, Chicago.

**POWER SUPPLIES**

A.C. POWER, less than \$5.00. Build a 300-watt, 110-volt, 60-cycle, public address or light generator. Complete plans \$1.00 or A.C. Power, P. O. Box 382, Vincennes, Indiana.

**RADIO**

RADIO PARTS—WE CARRY EVERYTHING for receiving and transmitting. Wedel Company, Inc., Wholesale, Seattle, Washington.

CRYSTAL SET—Something new. Separates all stations. Operates speaker. 750 miles verified. Blueprint 6 others, 25c coin. Modern Radiolabs, 151-B Liberty, San Francisco, Calif.

**MAILING LISTS**

Pave the way to more sales with actual names and addresses of Live prospects.

Get them from the original compilers of basic list information—up to date—accurate—guaranteed.

Tell us about your business. We'll help you find the prospects. No obligation for consultation service.



**FREE** 60 page Reference Book and Mailing LIST CATALOG

Gives counts and prices on 8,000 lines of business. Shows you how to get special lists by territories and line of business. Auto lists of all kinds. Shows you how to use the mails to sell your products and services. Write today.

**R. L. POLK & CO.**  
Polk Bldg.—Detroit, Mich.  
Branches in Principal Cities  
World's Largest City Directory Publishers  
Mailing List Compilers, Business Statistics. Producers of Direct Mail Advertising.

**The Hotel Royal**

The HOMELIKE Hotel of Philadelphia  
at Broad St. & Girard Ave.  
Philadelphia, Pa.

Combines every convenience and home comfort and—commends itself to people of refinement.

WITHIN 5 MINUTES OF CITY HALL

Rates as low as

\$1.50 \$2.00 \$2.50—Single  
2.50 3.00 & up—Double

We make it our business to please  
Ask for Mr. Thatcher, Mgr.

ers of the cars, they sometimes make very good noise pickups out of what was meant to be an efficient radio aerial.

Next bond all the pipes, wires and control rods coming through the bulkhead, on both sides, grounding both securely and soldering all connections. Ground the electrolock cable as well as the speedometer cable at several places along their lengths—first making sure that the metal you are grounding it to really is a ground and not "above," or just hanging onto a wood frame-piece.

If after all these precautions have been made a great deal of the noise is not removed, obtain a piece of copper screen and place it under the floor mat, directly beneath the location of the set, and ground this securely to the bulkhead. If an overhead antenna is being used, make sure that the springs in the seats and back of the seats are all well bonded together and grounded to the chasses of the car; as well, ground all the metal accessories which may be placed on the car. The robe-rail of one particular open car caused two men to spend over three-quarters of an anxious hour on a car only to find out that this member was screwed into a wooden back-post and was not grounded. When this rail was grounded securely to the chassis, a drop in the ignition noise level which was really unbelievable was noted.

The writer has a penchant for under-car aerials. Whereas the overhead antenna may be more efficient in some instances—I like to know that my results will be the same all the time, so for that reason always use the same style antenna, supplementing it from time to time with the car aerial furnished when it proves to be as good as the under-car aerial. The aerial used is simply a piece of copper screening a foot and a half wide and from six to seven feet long, set in a flat bag made of top material (water-proof, of course) and with a tape at each of the four corners. Fastened between the front and rear axle of a car they are neat, clean, efficient and cost but 45 to 50 cents to make up.

The following are some of the methods regularly used to eliminate noise in some of the most popular makes of cars on the market. To list all of the cars would be too great a task, but the few popular ones noted cover about all the methods used.

**BUFFALO.**—Battery lead installed in shield, antenna wire shielded, suppressors and condensers connected. A small piece of screening sometimes used on floor of car under set, securely grounded to frame. This will generally eliminate all of the noise in these cars as they are the easiest to work on, everything electrical about the car being shielded and the spark plugs being encased in the block.

**CHEVROLET.**—Coil moved up and fastened to motor block in close relation to distributor. Leads from switch to coil being run in a twisted pair, shielded in copper shielding. This lead should be run in such fashion that it passes low on the motor block alongside of the distributor. Build up the rotor of the distributor. Bond all wires, pipes and control rods coming through the bulkhead on both sides and ground well. Install set on right side of car. Use all suppressors and condensers, and if a slight noise is still heard use a condenser on the switch or battery side of the coil. On some of the earlier models of this car, notably the 1930 and 1931, it was necessary to install a fairly heavy R.F. choke in the "A" lead, bypassed to ground.

**PONTIAC.**—Place coil in motor compartment near distributor and follow precautions as outlined above for the "Chevy." In addition it is sometimes necessary to bond and ground all the cushion springs and robe racks. An under-car antenna is generally more efficient on the smaller closed models and roadster jobs of this make.

**DODGE.**—Use highly efficient under-car antenna and extremely short leads from coil to distributors. Shield all ignition leads from switch and use condensers on switch side of coil to ground. For some undecipherable reason it is sometimes necessary to run the wires from the distributors to the plugs in shielded wire. When this is being done make sure however that there is sufficient space left between the suppressors and shield to avoid a jump-over to ground. Regulation Packard "Lackard" shielded ignition wire

## PORTABLE PUBLIC ADDRESS EQUIPMENTS!

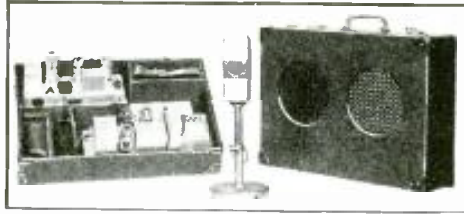

**TYPE PG-62**—A complete Portable Public Address System, including the famous VELOCITY MICROPHONE, a high grade Class B 20 watt amplifier, and two modern dynamic loudspeakers—all self-contained in one convenient carrying case. Operates on 110 volt AC and is designed to faithfully reinforce speech and music. Has provision for electric phonograph input.



**TYPE PG-63**—A smaller and lighter design including close talking carbon microphone, Class B 6 watt amplifier and dynamic loudspeaker—all self-contained in one convenient carrying case. Operates on 110 volt AC and is designed to reinforce speech and music, and has provision for electric phonograph input.

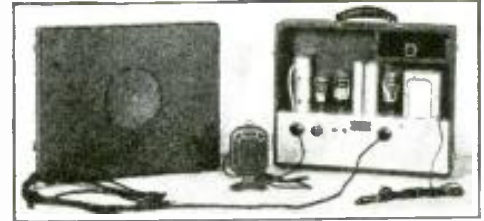

A full line of high quality sound reinforcing equipment is available for permanent installations.

Surveys and estimates furnished on request and without obligation.



Write for descriptive literature.  
ANYTHING IN SOUND REPRODUCTION  
Photophone Division



**RCA VICTOR COMPANY INC.**  
"Radio Headquarters" CAMDEN, N. J.



### WAKE UP . . . ! STOP DREAMING !

• Radio Offers a Real Future  
For Ambitious Men—

To the man who has time on his hands just now—the man who wants to put that time to thinking of the future—CREI offers a complete home study course in Practical Radio Engineering.

Not only is this extension course prepared for the average radio-minded man, but it consists of a series of instructions in specialized training for those radio men who know that technical training will give them that needed knowledge and ability to forge ahead to bigger things!

**FREE . . .**  
**Illustrated Booklet**  
Containing complete information regarding our various courses—write for it today!

### CAPITOL RADIO ENGINEERING INSTITUTE

14th and Park Road, N.W. (Dept. RC-11)

Washington, D. C.



**THE NEW SHALLCROSS WHEATSTONE BRIDGE (No. 630)**

This inexpensive, rugged, and reliable instrument can be easily handled by electrical technicians. Good accuracy is attained by employing a set of very accurate SHALLCROSS Resistors and a sensitive I. & N. Galvanometer.

Range, .01 ohms to 11.1 Megohms  
Send for stamps for Bulletin 630-P containing full information and construction details  
**SHALLCROSS MFG. CO.**  
703 MacDade Blvd. Collingdale, Pa.

On page 305 of this issue you will find an important announcement which tells about the OFFICIAL REFRIGERATION MANUAL and the new material added . . . now bringing this valuable book right up to the minute with new servicing material.

# Radio-Craft FREE BOOKLET SERVICE

## READERS' BUREAU

On this page are listed manufacturers' catalogs and booklets, chosen because they are of interest to readers of RADIO-CRAFT. You can obtain copies FREE by using the coupon below.

5. **CLAROSTAT CONTROL HANDBOOK.** A large 32-page book containing detailed specifications of volume controls, attenuators, constant-impedance controls, phonograph pickup faders, tone controls, line ballasts, rheostats, potentiometers and fixed resistors of various kinds, together with valuable circuit-design data. *Clarostat Manufacturing Company, Inc.*

6. **MEASURING RESISTANCE BY THE DEFLECTION METHOD.** The conventional method for the measurement of resistance involves the use of the Wheatstone bridge, a costly piece of apparatus. However, there are other methods which provide a fair degree of accuracy, enough for all practical purposes. The least expensive is the deflection method, which makes use of popularly priced milliammeters and fixed resistors. This bulletin describes the method completely. *Shallcross Manufacturing Company.*

11. **SUPREME INSTRUMENTS.** Contains lengthy descriptions of the Supreme service instruments, including the AAA1 Diagonometer, which is five instruments in one, the model 90 analyzer, the model 40 tube tester and the models 60 and 70 oscillators. Interesting to the Service Man because it tells how his work is facilitated by ingeniously-designed test equipment that indicates the condition of an entire set in a few minutes. *Supreme Instrument Corporation.*

19. **A BAPTISM OF FIRE.** Centralab fixed resistors are made by forcing a carefully calibrated resistance material through a plastic ceramic material, and then baking both under terrific heat. This booklet describes the manufacturing process in detail, and lists the advantages claimed for fixed resistors of this type. *Central Radio Laboratories, Inc.*

12. **READRITE RADIO INSTRUMENTS.** This sixteen-page pamphlet contains some valuable hints on the testing of electrolytic condensers, as well

as descriptions of the full line of popular-priced Readrite instruments. Worth having. *Readrite Meter Works.*

76. **THE COAST-TO-COAST "BROADCAST."** The "Broadcast" is the Spring-Summer 1933 edition of a 100-page mail order catalog that is a veritable encyclopedia. Every article is well illustrated and described for the benefit of radio dealers and Service Men, for whom the volume is specifically intended. *Coast-to-Coast Radio Corporation.*

94. **ELECTRAD PRODUCTS.** The newest and latest catalog of Electrad products contains twelve pages and lists many types of fixed and variable resistors and five different kinds of amplifiers for public address purposes. The popular Truvolt resistors have been improved by the addition of insulating shields and heat radiating covers, and a number of new sizes have been added to the line. A handy and useful catalog. *Electrad, Inc.*

96. **TOBE FILTERIZER AND CONDENSERS.** The Tobe Deutschmann company is now catering to the Service Man with an extensive line of filter, by-pass and line condensers and radio noise eliminators. A full page is given to the new "Filterizer" noise eliminating antenna system, an item of particular interest to Service Men because of the money-making opportunities it offers. *Tobe Deutschmann Corporation.*

97. **ARCO TUBE BULLETIN.** A descriptive folder giving full technical characteristics on the complete line of Arco radio receiving and transmitting tubes, photo-electric cells, television lamps, hot and cold cathode tubes, cathode ray tubes, rectifiers and charger bulbs. This can be posted for easy reference. *Arco Tube Company.*

98. **HOW TO USE NOISE REDUCING ANTENNA SYSTEM ON BROADCAST WAVES AND SHORT WAVES** is the title of the latest booklet on this important subject. In addition to covering the theory, the practical application of the various noise-reducing systems available for broadcast and short wave use, is described also. *Lynch Mfg. Co.*

102. **AMERICA'S OLDEST RADIO SCHOOL.** This attractive 16-page catalog describes the various course of instruction available at the RCA Institutes in New York and Chicago. Training is given in the following subjects: radio broadcasting, radio operating, radio servicing, and sound and public address work. Home study courses are also offered. *RCA Institutes, Inc.*

103. **MILES PUBLIC ADDRESS SYSTEMS.** A concise 8-page catalog listing microphones, loud speakers, power units, amplifiers, transformers and incidental accessories. *Miles Reproducer Co., Inc.*

104. **WESTON STANDARDIZED SERVICE UNITS.** This folder describes a complete series of standardized service units, consisting of an analyzer, tube checker, oscillator, volt-ohmmeter and capacity meter. *Weston Electrical Instrument Corp.*

105. **RADIO BARGAIN NEWS.** This dealers' and Service Men's mail order catalog is a veritable buyer's guide. Among the hundreds of items included are auto radio sets, mobile sound amplifiers, dynamic speakers and replacement parts of every description. *Federated Purchaser, Inc.*

106. **EX-STAT SPECIALTIES FOR RADIO SERVICE TECHNICIANS.** A useful catalog of resistors, condensers and volume controls, prepared especially for the Service Man. Of particular value is a ten-page section listing the correct replacement volume controls for numerous radio receivers dating back as far as 1926. *Tilton Manufacturing Company.*

107. **SHURE TECHNICAL BULLETIN.** A 4-page bulletin published monthly, and devoted exclusively to the advancement of microphone technique. *Shure Brothers Co.*

split for about an inch or so and that part of the shield removed, is generally O. K. Ground all shielding well but take care that in doing it no chance of grounding due to rain is possible.

**CHRYSLER.**—Coil moved up next to distributor and all wires on both sides of bulkhead shielded and bonded. Coil bypassed and a goodly portion of shielding used under floor mat in region of set. Under-car aerial preferred.

**PACKARD.**—Best results are met with the use of an under-car aerial in addition to overhead aerial when car is furnished with same. Thoroughly bypass all coil leads and shield ignition wires from coil to distributor. Some of these jobs have had to have the coils moved up to the front of the motor block. There are a great many custom-built body jobs in this class and great care will have to be taken in bonding the cushion and back springs. Bypass all dome light leads at the light, and ground thoroughly not only the protective cable on spotlight but also the standard used to hold the spare tire in the fender "well" on the sport jobs.

**AUBURN.**—One of the toughest cars to work on is this job. This is especially true of the models which encase the leads coming from the distributor in an aluminum-topped hood. It is necessary to spare no pains or copper shielded wire on this car, as every available lead must be thoroughly shielded, every control rod bonded and grounded, and the coil placed in close relation to the distributor. Also ground all metal floor panels that are not already grounded. Run the "A" battery lead-in shield from the ammeter lead or starter positive. Make sure that every piece of metal in the chassis, even down to the window raising mechanism is grounded, as well as grounding thoroughly the frame holding the spare tires. If the car uses a tonneau windshield as so many of this make do in the open cars, ground this and the metal back of the front seat thoroughly, not being content with merely grounding the metal back and relying on the screws holding the windshield to bond it to the back. To the Service Men who can lick an Auburn completely on the first "crack" belongs the title "The complete 'Auto-trician'." It has been done, but generally if an Auburn comes into the shop the owner is given to understand that some little noise may be present "at times." This is to forestall calls when the owner finds other, less expensive cars with little or no noise at all. It can be reduced to a minimum by careful work and attention to details as shown in the first part of the article.

**FORD.**—This is another easy car to work on, especially some of the older model A's, as all that is necessary in these cars are the suppressors, and condensers, and shielding of the coil leads. In the later models the 4's and V8's it is a little harder as the distributors will have to be dressed down and the coil sometimes moved up. Bonding and grounding of all wires and control rods is of course part of the job. In the two-door sedans it is best to supplement the overhead antenna with an under-car aerial, and also bond and ground the springs of the back seat.

**PLYMOUTH.**—Coil should be moved up to the distributor or placed as far front as possible. Shield and bond wires on both sides of bulkhead. Not much trouble. However, on account of the "floating power" feature of these cars some trouble is experienced due to incomplete electrical bonding of the block to the chassis. A copper bond strap made from shielding, fastened under one of the bolts and thence to frame will lick it easily.

Now a word at this time about the care necessary when working on and around ignition systems. A "short" plays havoc with a car battery and if when changing coils around and rewiring ignition systems for new switches there is any chance of a short, take the time first to disconnect the positive lead from the battery and then go on with the work. Remember also, that a grease spot on the upholstery leaves a bad impression on the customer, besides showing you up as a careless worker. If you want repeat business the surest way of getting it is to do good, clean work and let your own customers

RADIO-CRAFT 5-107  
Readers Bureau  
96-98 Park Place, New York, N. Y.

Please send me free of charge the following booklets indicated by numbers in the published list above:

No. ....

Name .....

Address .....

City..... State.....

(Please check the following)

I am

(1)  Service Man (2)  Experimenter

(3)  Dealer (4)  Jobber

(5)  Radio Engineer

(6)  Licensed Amateur

(7)  Professional or Amateur Set Builder

This coupon will not be honored unless you check off your classification above.



send around their friends. Fully 75 per cent of the work done last fall was on recommendation in the shop, simply because the men were clean and courteous. Where a man sees a fellow in a nice clean suit of white coveralls and with clean hands working on his car, and the upholstery covered over with nice greaseproof covers, the wheel covered with a cloth, and a shield over the painted parts—it leaves an indelible impression.

If you are going to specialize more or less in this installation work—and it is one of the few branches of radio now really active—get a complete set of wrenches suitable for the removal of the bolts and nuts on the motor and chassis. Also make sure that each job is really finished to the best of your ability before it is turned over as completed. It is far better to advise a customer that "It was impossible to complete the entire job today to my satisfaction—I will finish it at your own convenience tomorrow," than it is to let a customer go out with the idea that you have not done the job right and be forced to come back.

Make *positive*—and the italics should be hearkened to—that when you work on a car nothing is left undone when the job is turned over. All bolts and screws should be as tight as they were when you got the car, and every wire should be properly installed so that the shielding cannot possibly short out anything and cause any trouble.

For emphasis, let me state a case in point. An owner of a car (a Packard, to be exact) had one of his neighborhood radio men install a radio set in his car. The job was turned back presumably finished. But—the next day the same radio man was visited by an irate car owner *and his attorney!* In doing his work the man had loosened up a bolt on the steering column to enable him to bolt the set into the corner "out of the way." This bolt was not put back securely and that evening when driving the bolt had dropped out, the steering column became loose and an accident had ensued. The man was held liable because it was afterwards proved that it was his negligence which had caused the trouble and he had to "soak up" \$700 for the damage. \$600-00 (to emulate that fire-whistle of the air, Ed. Wynn)—when you take it off, put it back so tight that the next fellow will have trouble taking it off again.

Some cars have double ignition systems, and these contrary to the first notion will not be as hard to work on as a first glance would seem to indicate. However a word about these: don't "fool" with the spacing of the points of these systems, as a fraction of an inch in their placement means trouble with the car. Building up the rotor is O.K., but do not try to dress the points down or bother with their adjustment unless you are an ignition specialist and have worked on double ignition before.

As a final word, the actual mounting of the set in the car is simple, but before you promise the complete installation in "one hour" prepare to have a half-dozen experts ready to work on the car so that it can be done. Ask a fair rate per hour for outside work and keep in touch with the neighboring automobile sales agencies. Do their work for them and see how many of the friends of the owners of new cars will come around and "get one put in."

In the matter of just what charges should be made, a great deal will of course depend upon your location. For the average installation of a new set a charge of \$10 is made to the customer. Where the work comes from one of the automobile agencies who most naturally have to be "counted in" on the labor, there is a tacit understanding that they are to bill the customer for this amount and their commission of \$2.50 is deducted from this figure.

On all outside work where it is simply "noise elimination," a flat rate of \$1.00 per hour is fair. This should be adhered to in all cases and no cut rates given. It will be found that a great deal of this work can be obtained, especially, from car owners who have had their sets installed in an unsatisfactory manner and have never received satisfaction from the original installation man—either because of lack of knowledge on his part as to the correct procedure, or because of no desire to satisfy the customer.



# HEADQUARTERS FOR PUBLIC ADDRESS AMPLIFIERS

BUY DIRECT from MANUFACTURER and SAVE BIG MONEY!

*Fifty Two Models Available for use in all Automobiles and all Indoor and Outdoor Installations, such as Universally Powered Models—Operating from 110 Volt A.C. or D.C. or from a 6 Volt Storage Battery, with POWER OUTPUTS RANGING from 3 TO 100 WATTS!*

Here is **BIG VALUE** Victor Push Pull 245 Amplifier

Excellent For All Microphone, Phono, Pickup And Radio Tuner Amplification Applications.

Instantaneous Heater Amplifier (ideal for "Call Systems")  
models 1-229, 2-243, 1-280, Standard Model nos. 1-50, 2-245, 1-280. Equipped with an output push-pull transformer for 7-ohm speaker coils, and a phono-input transformer, etc. Features D. C. Field current from 2500 volts 110 Volt D. C. Dynamic Speakers. High zinc chlorate tubes, and use of two A. E. stages, assure enormous volume in "talkie" and phono-pickups. Completely assembled kit; anybody can wire this amplifier easily... wiring diagram furnished. 110 volt A.C., 60 cycle.

**ASTOUNDING VALUE** \$6.95  
LESS TUBES & SPEAKER

SET OF TUBES \$1.69  
 MATCHED DYNAMIC SPEAKER \$1.95

**COAST-TO-COAST RADIO CORP.**  
 123 K-WEST 17TH STREET, NEW YORK, N. Y.

## Announcing Amazing Typewriter Bargain

New Remington Portable only 10c a Day  
**10-DAY FREE TRIAL OFFER**

Only 10c a day buys this latest model Remington Portable!

Not a used typewriter. Not a rebuilt machine. It's a brand new, regulation Remington typewriter. Simple to operate, yet does the finest work. Full set of keys with large and small letters.

Try this typewriter in your home or office on our 10-day FREE TRIAL OFFER. If at the end of 10 days you do not agree that this Remington is the finest portable at any price, you can return it at our expense. Don't delay. Don't put it off. Mail the coupon today. Or use postcard if you prefer.

Write for our new catalogue showing the most complete line of portable and desk models ever offered.

**FREE TOUCH  
 TYPEWRITING COURSE**



**MAIL  
 COUPON**

for full facts about  
 this astounding offer

REMINGTON RAND INC., Dept. RC-4  
 BUFFALO, NEW YORK.

Please tell me how I can buy a new Remington Portable Typewriter for only 10c a day. Also enclose one of your new catalogues.

Name .....

Address .....

### FLASH-OVER IN 83 TUBE

Radio Service Men working with P.A. amplifiers and amateur station operators have been puzzled by the flash over which sometimes occurs in the type 83 full-wave mercury vapor rectifier tube.

This condition is explained as follows by the National Union Radio Corp.: "In the handling and shipping of the 83 tube, the excess mercury often deposits itself in a film across the stem of the tube thus forming an electrical path between the electrode connections. It is the burning away of this deposit which causes the flash over.

For really ideal operation, the filament *only* should be allowed to burn for a period of three or four minutes. After this the plate voltage may be safely applied. This burning of the filament will warm the tube sufficiently to drive off the condensation of mercury on the stem.

The type 83 tube is designed to stand an applied voltage of 500 V., r.m.s. per plate and deliver 250 ma. D.C. output. Providing the tube is operated within this rating, excellent life will be secured, but overloading will cause early failure. The application of higher A.C. voltage than 500 V., per plate will cause electrolysis in the glass stem which results in stem rupture."

## DUMONT

"Best By Test"

Dumont's complete line of Electrolytic Condensers, Paper and Tubular, enable Service Men to make replacements in an unusually large number of radio receivers, including all late model auto-radios and midget sets. Dumont Condensers are recognized by their superiority, quality and permability in retaining their values.

### MODERN RADIO ACCESSORIES

The wide variety of replacement parts carried by Dumont permits Dealers and Service Men to purchase Standard replacement parts at prices which are exceedingly low. The quality of Dumont's products are only of the finest. Send for free catalog listing hundreds of replacement parts, for standard radios.

Dumont Electric Co., Inc.  
 453 Broome St., New York, N. Y.  
 Jobbers and Sales Territory Open

# SUPREME MODEL 333



## The Biggest \$39.50 Worth of Analyzer Anywhere

The new Model 333 is a modern Analyzer combined with a point-to-point tester, and enables (1) complete point-to-point re-tance, voltage, and current analysis; (2) tube testing from the radio socket with self-contained grid shift battery; (3) capacitor leakage tests, including electrolytic capacitors; (4) use of head-phones, loud speakers, microphones, etc., connections for all miscellaneous tests and (5) set range output meter available for convenient use without the necessity of troublesome output adapters.

In using the Model 333 It is unnecessary to remove the chassis of the radio or to dismantle it in order to gain access to the circuits for "point-to-point" tests with test probes as is necessary with the usual "point-to-point" set tester. Any meter range may be applied thru the analyzer cable including those for resistance and output measurements. Provides A.C., D.C., M.A., output ranges of 0/5 25/125/250/500/1250 mills or volts; Resistance ranges of 0 1,000/10,000/100,000/1,000,000 ohms; and capacity ranges of 0/125 1.25/12.5 mfd. All readings direct on meter—no charts. Uses Supreme's exclusive FREE REFERENCE POINT SYSTEM OF ANALYSIS. 60 cycle.

Dealers Net Cash **\$39.50**  
Wholesale Price

Ask your Jobber for demonstration—write for complete Catalog. Order now—higher prices are certain.

**Supreme Instruments Corp.**  
478 Supreme Bldg. Greenwood, Miss.

## NEW AMAZING AERO INTERNATIONAL ALL WAVE 11 TUBE SUPER De LUXE



Here now! World Wide Reception. No plug in coils. Automatic volume control—100% shielding—new superphonic tubes. Get ALL the programs—short wave and broadcast. Buy now at this remarkably low price.

Completely Assembled With 2 Matched Full Dynamic Speakers **\$29.75**  
Tubes \$7.75

## AERO WORLD WIDE



1-Tube Short Wave Set for Head-phone Operation **\$5.95**

Enjoy the thrill of listening DIRECT to Buenos Aires, London, Berlin, Paris, and other broadcasting stations throughout the world, via SHORT WAVES. The AERO WORLD WIDE RECEIVER gets 15 to 650 meters. For the last seven years this little wonder set has been one of the biggest sellers in the Short Wave Field.

Complete line of radio sets and transmitting apparatus  
Write for FREE Catalogue

**CHARLES HOODWIN CO.**  
4240 Lincoln Ave., Dept. G-15 Chicago  
Please send your NEW 1933 FREE CATALOGUE.

Name.....  
Street.....  
Town..... State.....

# BEGINNER'S 2-TUBE

(Continued from page 292)

substance to us, we are used to the "feel" of it and would prefer to use it for baseboards. But it is a very poor material for radio construction, so let's get away from it. Aluminum, being a very soft metal, can be handled just like wood in many ways, it can be worked with regular wood working tools, and it makes for far superior construction.

## Construction

The first job is to make up the chassis as shown in the drawing, Fig. 2. If you built the circuit shown last month you have only one to make, otherwise you must build them both. Do your work carefully and exactly and hold as closely as possible to the dimensions given, since these same units must "tie up" in the future with other units built to go with them. It is advisable, also, to build two separate units as shown because, while they are side by side this time we may decide to take them apart for another layout.

First cut out the four pieces required for the two panels and two chassis, then lay them out with a scribe and center-punch, and "spot" all holes with a small drill, say about 1/16-in. Then, drill through all the holes on the panels, and all except the socket holes on the sub-panels. Next, bend up the sub-panels, being sure to make sharp corners exactly on the dotted "bend lines" (shown on the drawings) and cut out the socket holes. After this the panels and sub-panels may be bolted together and a small piece of aluminum about 1 1/2 in. x 3/4-in. wide may be bent lengthwise into an angle and used to hold the two units together by being bolted below the sub-panel to one of the bolts, on each unit, that hold the panel in place. This angle will be all that is necessary, though if you insist on an unusually solid job you may also place another similar angle between the two units at the back of the sub-panel.

After the chassis is completely assembled you may take the available apparatus for which holes could not be specified (since they mount in such a wide variety of ways), such as coils and tuning condensers, and arrange them on the chassis in the most convenient way. Be sure to keep the two tuning coils, L1, L2, and the two R.F. chokes as far from each other as possible, and with their axes at right angles in order to avoid feed back. After everything is arranged to your satisfaction mark out and drill the mounting holes and fasten everything down.

If you built the unit shown last month and are adding to it, it will be necessary to remove the filament switch from the panel and substitute for it the combined switch and volume control which is being used in this circuit.

## Wiring

If you are starting a brand new job you may now proceed with the wiring, making good, solid soldered joints especially in the case of bypass condensers where the pig tails are depended upon to hold the condensers in place, mechanically.

Use solid, push-back wire throughout. Wire in the filament circuit first, then the grid wiring and finally the plate wiring, keeping all leads as short and direct as possible, and being particularly careful to avoid running the grid wiring close, and parallel to the plate wiring at any point as this will cause feed back and unstable operation. Mark out each wire

on the diagram as you put it in place and you will avoid mistakes and omissions.

If you are adding to last month's unit the following changes will have to be made in the circuit of the original unit and had best be made before proceeding with the wiring of the new unit.

Change the R.F. choke and its associated bypass condenser, from the grid to the plate circuit of the output tube, as shown. Completely disconnect the primary of the 3-circuit tuner and leave it "floating"; also disconnect the antenna wire from this coil. Wire the tickler of the 3-circuit tuner into the plate circuit of the output tube, as shown. Remove the 750 ohm bias resistor and wire in the 100 ohm and volume control resistors, as shown. The power cable is made by cutting four wires (with differently colored insulation) as long as required to reach from the set to the batteries, and soldering the end of each into one of the four prongs of an old tube base, braiding the wires together and pouring insulating wax into the tube base to hold the wires in place.

## Operation

After all the wiring is in place and you are sure, and doubly sure, that everything is O. K., you are ready to put the set into operation.

Plug in the phones, tubes, power cable and crystal detector, making sure that the little wire in this last unit is making contact with the crystal, and attach the "A" battery and the negative side of the "B" battery. When the volume control knob is turned to the "on" position of the filament switch the tubes should light with a very dull red glow. If they don't, find out why before proceeding further.

Now turn the volume control to the full "on" position and snap the positive "B" wire across the battery post. A sharp click in the phones and no large spark indicates that the circuit is probably wired correctly and the connection may be made permanent.

Make a temporary ground connection to the unused primary of the 3-circuit tuner and attach a good, outside antenna to the other end. Moving the adjustment of the crystal detector should now result in clicks and scratches in the head phones and when a sensitive spot is touched you will hear the familiar rushing sound always present, due to atmospheric. When such a spot is found leave the detector alone and "fish" for a station with the tuning and regeneration controls. One position or the other of the tickler with its axis parallel to the main coil will give regeneration and the whistling char-

(Continued on page 314)

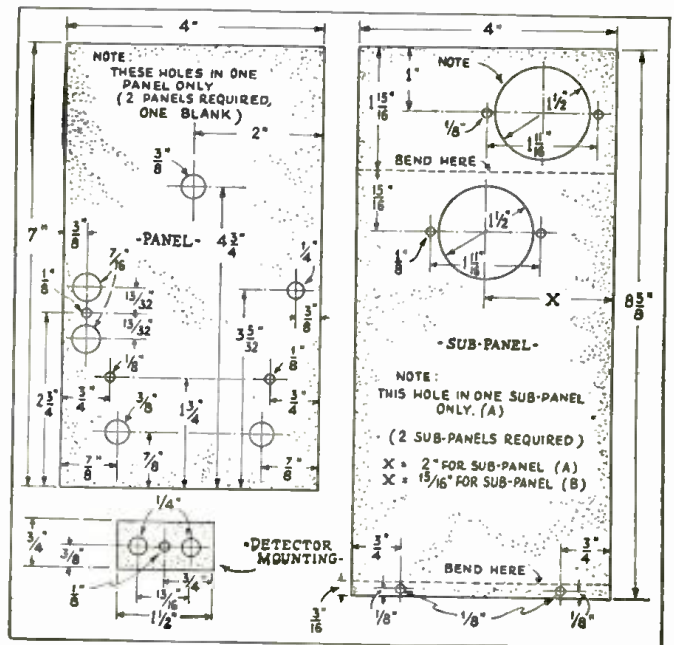

Fig. 2  
Details for making the aluminum panels and sub-panels.

# INFORMATION BUREAU

(Continued from page 234)

testing with the floating-oscillator tubes out of their sockets.

Similar tests should be performed with the floating oscillator, reversing the leads of L1, if necessary. When it has been determined that both oscillators are oscillating, try again to get a beat note in the instrument receivers. It may be necessary to add to or remove a few turns of wire from coil L3, because variations in mounting this coil with respect to the shielding surface will vary its characteristics sufficiently to throw it out of tune. It should not be necessary to add turns to L4 if V1 is up to par and is being operated at its rated filament potential (check this point, by means of an accurate voltmeter).

(7) Many builders seem to be having trouble getting parts to build the outfit; the author will be glad to give any desired assistance in this connection.

(8) The values of component parts shown in Fig. 1, the schematic circuit, are satisfactory; however, units C1A and C2A may be changed to conventional trimmer condensers of smaller capacity.

The schematic circuit shown as Fig. 1 in the July, 1933 issue has been modified slightly to secure improved operation, as mentioned above. Therefore, the circuit has been completely checked over and these slight revisions included in the circuit shown here as Fig. Q, 222. Note that in this circuit the capacities of the tuning condensers in shunt to L1-L2, L3 have been increased because the previous values were so near the dead-line of inoperative characteristics that the instrument was extremely difficult to adjust in order to secure a beat note. The values are: C1, 350 mmf., variable, with vernier dial; C1A omitted; C2, .0015-mf.; C2A, 350 mmf., variable, with insulated shaft and vernier dial. Since several constructors have stated that they had considerable difficulty in locating the filament ballast resistors, the circuit has been rewired so that any three, 2 V. tubes drawing equal amounts of current can be used without a filament series resistor.

The two milliammeters are of light weight, inexpensive type and are used merely as indicators. When the set is first turned on, they show a heavy flow of current; then, the falling off of current flow indicates that the system fed through the meter has started oscillating.

The large amount of variable capacity in the tuning circuits makes possible the selection of a large number of frequencies and here a surprising condition is noted. *Some combinations of frequencies give far greater penetration and response than others.* Every point on the floating-oscillator dial should be worked against every point on the monitor

dial. Although this means 100 x 100 or 10,000 tests to find the most sensitive setting of the instrument, the results are well worth the effort and time involved.

Switch Sw.2 is used to cut out the grid bias on the two floating-oscillator tubes, permitting them to run "wild" and thus causing a heavy plate-current flow through coil L2. This creates a D.C. magnetic flux and if the tube circuit continues to oscillate it varies this D.C. flux from some point above an arbitrary zero. On some frequencies the instrument performs best when operated in this manner.

If any further trouble is encountered in constructing this metal locator, the writer will be glad to answer inquiries.

Franklin E. Sarver,  
2923 Harrison Street,  
Kansas City, Mo.

## PHILCO SHORT-WAVE CONVERTER

(223) Mr. John Kramer, Jersey City, N. J.  
(Q.1.) What is the power consumption of the Philco short-wave converter, model 4, when used with a broadcast receiver?

(A.1.) The Philco model 4 short-wave converter consumes 50 watts maximum. This converter has its own power supply unit, and for this reason, the type of set with which it is used has no effect on the current consumed.

(Q.2.) Why is it necessary to set the dial of the broadcast receiver at 1,000 kc. when using this converter?

(A.2.) The Philco model 4 converter contains the first-detector and oscillator circuits of a short-wave superheterodyne receiver, and the broadcast receiver becomes the I.F. amplifier, second-detector and audio amplifier of the system, when connected with the converter. As the short-wave portion of the set is designed to operate with an I.F. amplifier of 1,000 kc., the broadcast receiver must naturally be set to this frequency.

(Q.3.) How is vernier tuning on the short-wave converter made possible by using the broadcast station selector?

(A.3.) When the broadcast receiver dial setting is changed, the tuning of the short-wave circuit is changed by an equal amount. For instance, if the short-wave dial is set at 2 megacycles with the broadcast dial at 1,000 kc., a 2 megacycle signal can be received. Now, if the broadcast receiver dial is changed to 1,010 kc., the tuning of the short-wave converter will be changed to 1,99 megacycles, although the short-wave dial still remains at the 2 megacycle setting. Therefore it is much easier to make such a 10 kc. change in the tuning of the broadcast receiver than the short-wave converter. Thus, vernier tuning by means of the broadcast station selector is made possible.

# SUPREME MODEL 444

## Five Unit Radio Tester



Complete Laboratory Equipment at a Popular Price

The new Model 444 Five Unit Radio Tester incorporates the functions of a modern analyzer, an A.C. tube tester, a shielded oscillator, an ohmmegohmmeter, and a capacitor tester. The analyzer offers FREE REFERENCE POINT SYSTEM OF ANALYSIS, providing A.C., D.C., V.A., output ranges of 0.5/25/125/250/500/1250 millivolts or volts; Resistance ranges of 0.1,000/10,000/100,000/1,000,000 ohms and capacity ranges of 0.125/1.25/12.5 mfd. Tube tester accommodates all tubes including the newest types without adapters. A special 11-point 6-pin selector switch is used so that only four sockets are required for accommodation of all 4, 5, 6, small and large base 7 prong tubes. Tests all A, B, C, D, V, Z, series including duo-diode connections. Provides filament heater voltages of 1.5, 2.0, 3.3, 5.0, 6.3, 7.5, 12, 13, 25 and 30 volts. The A.C. D.C. specially stabilized and completely shielded 100% modulated oscillator insures utmost accuracy from 130 to 1875 kilocycles covering the 20, 40 and 80 meter short-wave bands. Complete laboratory equipment engineered into a single instrument.

Dealers Net Cash **\$89.50**  
Wholesale Price

Ask your Jobber for demonstration—write for complete Catalog. Order now—higher prices are certain.

Supreme Instruments Corp.  
477 Supreme Bldg. Greenwood, Miss.

# Make MORE MONEY in RADIO with R.T.A. Professional TRAINING

Home study with R.T.A.—plus lifetime membership in our large, powerful association of radio service men—brings you up to date on all improvements in radio, television, sound engineering, and keeps you among the real money-makers in this expanding field. Unless you have this high-type professional training you will find it hard to get out of the poorly paid "inkerer" class.



## New-Type Set Analyzer Included

As part of R.T.A. training you get this up-to-the-minute Set Analyzer and Trouble Shooter. After a few easy lessons you are ready to use it for immediate money-making, competing with old-timers without fear. With this wonderful piece of equipment backed by R.T.A. professional training, you need have no fear or worry over the future. Even though there should never be a new radio set constructed—or not another improvement in radio made—there are enough sets now in service that need frequent attention to assure you good money as an accepted Radio-technician.

## Start Money-Making Quickly

R.T.A. Training is especially designed—and given you by one of the outstanding exponents of radio technology in the world—to get you into the profitable end of radio quickly. It is an easy theory, but practical, down-to-earth work that makes you a money-maker right in your home field. No shortcuts, no "make-it-up" ideas. You start toward success. Write at once for all details about R.T.A. training. The program below lists FACTS—outstanding ones that can't open up a new, depression-proof future for you.

## MAIL COUPON NOW!

RADIO TRAINING ASS'N. OF AMERICA,  
4513 Ravenswood Av., Dep't. RCA-11, Chicago, Ill.  
Send me all the FACTS about R.T.A. professional training together with information about the opportunities existing for R.T.A. Radiotechnicians today.

NAME.....  
ADDRESS.....

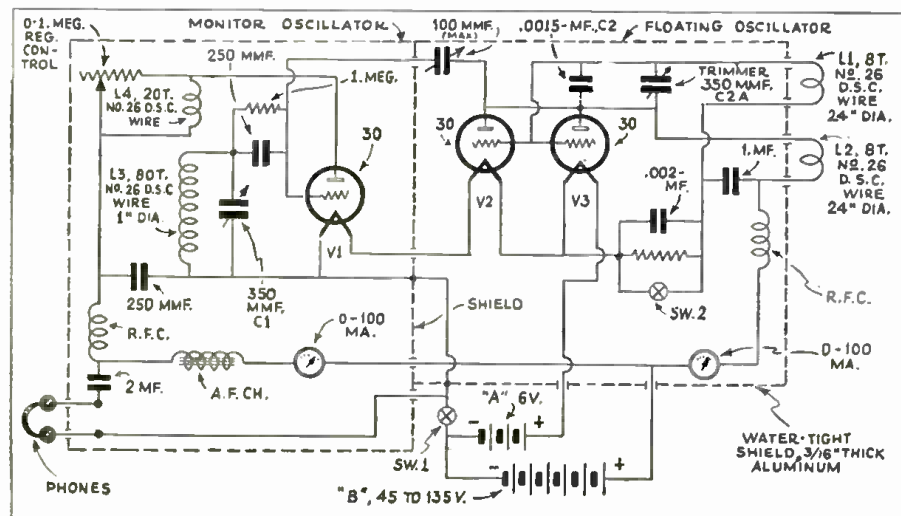

Fig. Q, 222

The "treasure" finder diagram as revised by Mr. Sarver.



Outside View of Aircraft Generator

# BARGAIN SALE of 3000 WESTINGHOUSE Power Generator Aircraft Transmitters

Hundreds of Uses for Radio Experimenters

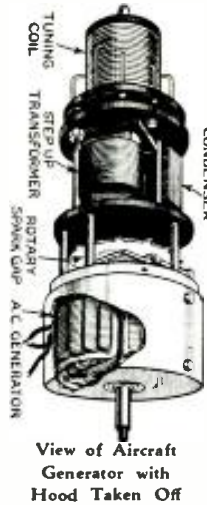

View of Aircraft Generator with Hood Taken Off

The Government Paid Originally \$147.00 Each for these Westinghouse Generators

OUR PRICE \$4.95 EACH AS LONG AS SUPPLY LASTS

## Technical Specifications

The special generator illustrated is of the self-excited inductor type. The rotor serves two entirely distinct purposes: 1. It carries the inductors for the A.C. generator, which has stationary field and armature coils. 2. It carries the D.C. armature, which corresponds to the exciter in other machines.

There are two pairs of stator poles—two North and two South. Around these four poles are wound the four field coils which, when energized, produce poles of alternate polarity. Each of these poles is provided with four slots into which are

fitted the A.C. windings. The rotor is a 12-tooth inductor that carries the D.C. exciter current required by the alternator; a built-in commutator takes off the generated D.C. Three leads extend through the casing to permit a 4½ V. flashlight-type battery to be switched into circuit for starting, and to control the A.C. output of the generator. Rotated at its normal speed of 4,500 r.p.m., the output is 200 W., at 115 to 125 V. (on open circuit), 900 cycles.

Manufactured by Westinghouse for the U. S. Signal Corps, the sturdy construction of this instrument recommends it to the technician. The rotor turns in ball bearings. In order to perfectly withstand the extremes of temperature and humidity encountered in air-craft service all the coils are thoroughly impregnated with a special compound and then baked. Shaft length (driving end), 2 ins.; diameter, 9/16-in.; the end is

threaded for a distance of ¾-in. At the end opposite from the drive the shaft extends ¼-in. Case dimensions, exclusive of the shaft, 4½x6¼ in. in diameter.

The output of this self-exciter generator is fed to a step-up transformer which, in turn, is fed to a 12-point synchronous rotary spark-gap;

a rocker permits the single stator point to be accurately adjusted to phase the spark and the power supply. The spark gap is included in a secondary that comprises a mica fixed condenser, and a tapped tuning inductance adjustable in the range of 250 to 550 meters. This coil consists of 25 turns of No. 14 wire wound on a threaded bakelite form 3 ins. in diameter and 3 ins. long; the over-all length is 4½ ins. One set of taps is brought to a contact plate at one end and provided with a switch; the other set is brought to a contact plate at the opposite end and provided with a pair of laboratory-adjusted contacts. A stream-lined bakelite housing slips over the entire transmitter assembly. The over-all length of generator (exclusive of shaft) and transmitter is 18 ins. Weight of complete outfit, 20 lbs.; shipping weight, 35 lbs.

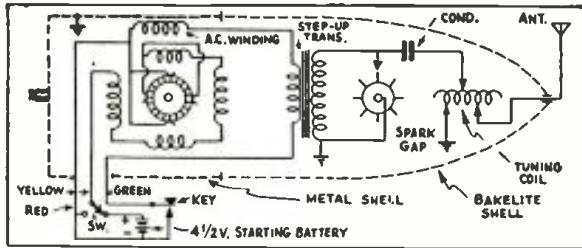

WELLWORTH TRADING COMPANY  
Dept. RC-11  
111 West Lake Street CHICAGO, Illinois

THESE GENERATORS HAVE NEVER BEEN USED AND ARE SHIPPED IN THEIR ORIGINAL PACKING BOXES. THEY ARE FULLY GUARANTEED TO BE AS DESCRIBED ABOVE.

WELLWORTH TRADING CO., Dept. RC-11  
111 W. Lake Street, CHICAGO, Illinois

Enclosed find \$4.95 for which ship by express collect one Westinghouse Power Generator Aircraft Transmitter as per your description.

NAME .....

ADDRESS .....

CITY .....

STATE .....

## BEGINNER'S 2-TUBE

(Continued from page 312)

acteristic when a station carrier is passed. Tune to the silent setting between the descending and ascending whistles and slowly rotate the tickler control until the whistle stops and the voice or music is heard.

With everything set thus, adjust the detector to its most sensitive point. Now disconnect the antenna and transfer it to the regular antenna post and tune in the same station with only the first tuning condenser. When you have done all this you have checked the operation of the receiver and logged your first station. Keep a record of it and go to it to see how many more you can log.

### Troubles

If you have wired the receiver carefully according to the diagram and illustrations you should have no trouble in securing immediate and satisfactory operation, however, a few hints covering the most likely troubles may help.

Absolute silence in the phones with the filaments properly lit indicates an open "B" line somewhere.

A buzzing noise indicates that the grid circuit of the output tube is open—probably at the crystal detector.

Crashes and rattles which occur intermittently, with the antenna disconnected, often indicate an old, run down "B" battery. This can be cured to some extent by the use of the 4 mf. bypass condenser shown dotted in the diagram; but the best cure is, of course, a new battery.

Inability to obtain the squeal or whistle when a station is tuned in indicates lack of sufficient regeneration and may be due to a number of different causes: a poor tube, low "B" voltage, excessive bypass effect due to the plate wiring being too close to the grounded chassis, a defective R.F. choke or bypass condenser, or insufficient tickler turns. The remedies to these faults are obvious.

In extreme cases it may be necessary to considerably increase the size of the 500 mmf. R.F. bypass condenser, but this should not be made any larger than necessary since it will affect the audio and cut down the volume. It may also be necessary to wire the tickler and unused primary in series as was done last month in the antenna circuit, this should give enough coupling to make the most stubborn circuit oscillate.

Excessive regeneration can most easily be reduced by decreasing the size of the 500 mmf. R.F. bypass condenser. However, if the oscillation should continue, even with the tickler shorted completely out of the circuit the trouble is in the R.F. amplifier stage and other remedies must be used.

The most common trouble in this case would be coupling in the wiring. Check this carefully, if moving any of the wiring around with a piece of wood or other insulator makes a change in the pitch of the note this wire is the trouble maker which must be cured, even to the extent of shielding that particular wire.

A tube shield, or a shield between the two units above the sub-panel may sometimes be necessary.

If the coupling appears to exist between the phone cord and other parts of the circuit the R.F. choke in the output plate is defective.

It is quite impossible to list here every type of trouble that all of you may run into, but enough has been said to point the way and a little sound, common sense together with a working knowledge of the operation of radio circuits will enable you to lick any problem which can arise. Remember, always, that every effect has a definite and logical cause, and if you can't find the cause—that's your fault; you don't know enough to find it and the remedy for that is study.

### List of Parts

- One 3-circuit tuner for 350 mmf. condenser, L2;
- One 2-circuit tuner for 350 mmf. condenser, L1;
- Two 350 mmf. tuning condensers, C1, C2;
- Two 85 mhy. R.F. choke coils, L3, L4;
- Two 85 mhy. R.F. choke coils, L3, L4;

# BEER—

## A NEW MONEY MAKING BUSINESS

### for Radio Service Men

Here is a new all-year-round money-making opportunity for men who have vision and fore-sight.

With the local sale of beer now practically established in every state, and rapidly growing into a large scale industry, all restaurants, cafes, bars, clubs and hotels are faced with the problem of properly conditioned equipment to keep good beer from sourness, bad taste and other deterioration resulting from uncleanliness.

The pipes and coils through which beer is pumped have to be kept meticulously clean. In many states there are very drastic regulating laws as to how many times each week all beer pipes and coils have to be cleaned in any establishment where beer is sold.

And here is where you Service Men come in to make money!

**SET YOURSELF UP IN THE BEER-PIPE CLEANING BUSINESS.**

All you need is our new, unique, compact, portable BEER PIPE-COIL CLEANER.

Go and visit your local restaurants, cafes, bars, clubs, and hotels, and make a service contract with the proprietors to clean their equipment once or twice a week, or often, at a fixed charge.

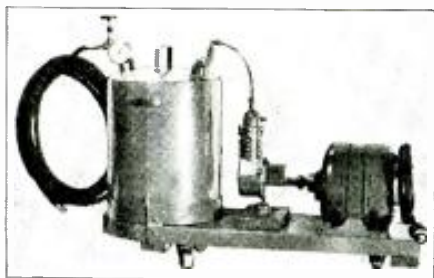

The price you pay for your BEER PIPE-COIL CLEANER will come back to you in earnings in a very few days of work, and every cent you take in after that will be clear profit—BIG MONEY FOR YOU!

The BEER PIPE-COIL CLEANER here described is scientifically constructed to do a thorough job of cleaning beer pipelines, coils, and faucets. It is ruggedly built for bar use and long service. There is nothing to get out of order.

We fully guarantee every one of our BEER PIPE-COIL CLEANERS against defects in either material or workmanship.

This portable apparatus consists of a 1/4 H.P. motor, a DIRECT DRIVE compressor, and a water-tank. The tank is provided with water-intake plug; pressure gauge; 60-lb. safety valve, water outlet faucet and hose connections for coil. The entire equipment weighs 42 lbs., and measures 27" in length, 11" in width and 18" in height. Shipping weight 55 lbs.

The whole outfit is portable, and mounted on a base equipped with small wheels.

To use the apparatus, all you have to do is to plug your motor into any A.C. light socket, fill the tank three-quarters full of hot or cold water (to which you may add ammonia, sal soda, or any cleansing compound), start your motor until your gauge shows about 40 lbs. of air pressure, connect the empty beer line with your tank, open the beer faucets and force the cleansing liquid through the pipes and coils. Repeat the operation with clear water, and blow out the coils and pipes with air. This is all there is to it.

Under our introductory offer—here announced for the first time—this whole service equipment described above will be sold for a limited time at the special price of

**\$37.50**

(Shipped by Express or Freight Collect)

In any new business venture, one of the prime elements of success is to get in on the ground floor. Be the first one in your city to start this new service business! Cash in on the start! If you work it right, you will make a lot of money, and you will have work to keep you busy summer and winter.

Send us your order now, using the order blank below.

ORDER BLANK

WELLWORTH TRADING CO.  
111 W. Lake St., Chicago, Ill.

RC.11

Enclosed find \$37.50 for which please ship me by express or first-class one of your BEER PIPE-COIL CLEANER outfits.

Name .....  
Address .....  
City ..... State .....

One 250 mmf. mica condenser, C3;  
One 500 mmf. mica condenser, C4;  
One double unit, 0.1-mf. paper condenser, 250 V., C5, C6;  
One single 0.1-mf. paper condenser, 250 V., C7;  
One 25 mf., 25 V. electrolytic condenser, C8;  
One 4 mf. 250 V. paper bypass condenser, C9 (optional);  
One 70,000 ohm, 1/2-W. resistor, R1;  
One 100 ohm, 1 W. resistor, R2;  
One 500 ohm volume control potentiometer, with switch attached, R3;  
One Rotorit crystal detector;  
One type 34 tube, V1;  
One type 33 tube, V2;  
One 5-prong wafer socket;  
Two 4-prong wafer sockets;  
One open-circuit jack and insulating bushing;  
One Ant.—Grid. binding post strip;  
One power plug and 4-wire cable;  
One 2 V. storage cell;  
Three 45 V. "B" batteries;  
Two aluminum panels, 4 x 7 x 1/16-in.;  
Two aluminum sub-panels, 4 x 8 5/8 x 1/16-in.;  
One bakelite detector mounting, 1 1/2 x 3/4 x 1/8- or 3/16-in.;  
No. 6/32 brass machine screws, nuts and hook up wire,

## READERS' FORUM

(Continued from page 289)

known condenser value and Cx is an unknown.

In operating the circuit, the potentiometer is adjusted until no sound is heard in the phones. Now the resistance-capacity bridge is

balanced so that  $\frac{C1}{C2} = \frac{R1}{R2}$ . (At first the ratio

appears inverted but the reactance of a condenser varies inversely as the capacity.)

With the 600 ohm potentiometer R1, R2, and 2,000 ohm phones I used, condensers below .005-mf. did not give accurate results. However, by using more sensitive phones or a higher resistance potentiometer, smaller condensers could be tested. The same result might also be obtained by arranging an audio oscillator of higher frequency or more power. Any type of triode may be used in place of the 69; adjust "A" and "B" for best operation of the circuit, and tube selected.

WILLIAM A. EDSON,  
Olathe, Kans.

## A METAL HOLE CUTTER

The home constructor of radio receivers encounters a long, hard job, when he undertakes to cut the tube socket holes in a metal chassis (especially iron or steel).

The writer, a tool designer, first tried to make one entirely by hand using only the tools to be found in an average home workshop and found that a good, strong, serviceable one was practically impossible to make.

The holder shown in Fig. 3, is easily cut out of iron or steel with a hack-saw, but the holes require the use of a power-driven drill-press. The reaming of the two holes can be omitted provided a careful job of drilling is done by a good mechanic. If the holes are reamed, a drill about twenty thousandths smaller than 1/4-in. is used to bore them first, then a 1/4-in. reamer is used. If the holes are not reamed, a 1/4-in. drill is used to finish out the hole to size. These two holes should be a sliding fit on the drill rod that fits into them. A good mechanic will cut out the holder, lay out and spot the holes, then set the holder in a hand vice to drill and ream the two holes at one setting (to get them to run parallel).

The cutting end of the tool and one end of the pilot rod should be hardened. The hardening of the cutting tool must be very carefully done, for, if left too hard it will break; if too soft it will dull rapidly. The hardening is done by heating what will be the cutting end over a flame until dull red, then plunging it into thick oil or warm water. After which the end is polished bright with emery cloth and re-heated over a smaller flame until it is a very dark brown, just turning purple; it is then plunged into water.

### "HAVE YOU SEEN IT?"

Filled with valuable data. Characteristic of all RCA-Cunningham, Majestic, and other tubes. Dozens of circuit diagrams. Finest Public Address circuits and parts. Volume control guide—most complete ever published—volume controls for every set on the market. Resistance Tables—all sizes of wire and composition resistors. *New test equipment*—exclusive Radolek design. Nationally known radio sets. This is a real Profit Guide—a radical departure from every other publication in America. Your copy is free. Please enclose business card or letterhead. Write now—

RADOLEK CO., 131 Canal Station, Chicago

I am a Dealer  Serviceman   
I operate from Shop or Store ; from Home   
I own the following Test Equipment: .....

My training and experience is: .....

Name .....  
Address .....  
City ..... State .....

**RADOLEK**

# SERVICEMEN .....

Here are the new improved essential parts for the Revised Radio-Craft Universal Analyzer:  
 907WLC A New Small 7-Pin Latch-Lock Analyzer Plug complete with 5 ft. 8-wire cable... List \$5.50  
 974DSA, 975DSA, 976DSA, and 977DSA... List 5.00  
 456B Composite 4-5-6 Button Socket... List 1.50  
 427 Medium 7-contact Button Socket... List 2.25  
 427 A Small 7-contact Button Socket... List 2.25  
 91 De Luxe Insulated Screen-Grid Clips... List 2.25



Now is the time to modernize all of your test equipment. Don't delay any longer. Here are kits priced to fit every serviceman. Directions and diagrams included with all outfits. Each adapter has a bi-color ring with distinctive color-hand between heater holes to enable any adapter to be quickly joined to the analyzer plug.

Here is the professional model. Used on the latest Weston, Jewell, Hickok, Supreme, etc., testers. If you want the best get this kit. Has the famous Na-Aid Latch-Lock with rhombic release.  
 907WLA New small 7-prong Latch-Lock Analyzer Plug with Twin List \$1.50  
 974P8SA 7A to 4-prong Latch Adapter... 1.25  
 975P8SA 7A to 5-prong Latch Adapter... 1.25  
 976P8SA 7A to 6-prong Latch Adapter... 1.25  
 977P8SA 7A to 7-prong Latch Adapter... 1.25

C. G. Handle... \$1.50  
 974P8SA 7A to 4-prong Latch Adapter... 1.25  
 975P8SA 7A to 5-prong Latch Adapter... 1.25  
 976P8SA 7A to 6-prong Latch Adapter... 1.25  
 977P8SA 7A to 7-prong Latch Adapter... 1.25

907WLA KIT Complete as shown... \$8.50

Here is the set for those who want the lowest possible price. Uses the Handle Plug with the wired type "Make-Your-Own" small diameter associate adapters. Increased adapter height permits easy removal when left in socket. C. G. stud supplied. List \$1.50



977P 7-prong Plain-Type Analyzer Plug... \$1.50  
 974W 7 to 4-prong Wired Adapter... .55  
 975W 7 to 5-prong Wired Adapter... .55  
 976W 7 to 6-prong Wired Adapter... .55  
 977WA 7 to 7A-prong Wired Adapter... .55

977P KIT Complete as shown... \$2.50

8-Wire Braided-Covered Analyzer Cable... List 10¢ ft.  
**REPLACE YOUR OBSOLETE SOCKETS WITH THESE LATEST COMPOSITE SOCKETS**  
 456 4-5-6 Contact Composite Socket... List 50¢ ea.  
 477 7-7 Contact Composite Socket... List 50¢ ea.

It's here at last! The "Make-Your-Own" Adapter Kit. All the parts for making any required adapter, including all ten types of socket top-sections and small sized base-sections complete with over two dozen assorted extension, soldering, connection, (th) and control-grid terminals, connectors, clips and lead wires. 800 "Make-Your-Own" Adapter Kit complete. List \$2.50  
 Bought separately each 4, 5, 6, 7 and small 7 top or base section lists at 25¢ each.

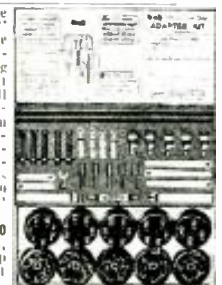

**GET THIS ADAPTER TO MODERNIZE YOUR TUBE CHECKER**  
 950XYL Universal Tube Checking Adapter tests over 100 NEAV TUBES. No wires - no leads - no jacks - very simple to operate - circuit diagram and direction chart listing over 100 NEAV TUBES with spaces for recording readings of these and future tubes are supplied with all orders. List Price... \$6.00  
 If your tube checker has no filament-voltage switch the 9548G1 adapter must be used on the base of the 950XYL. 9548G1 TYP top-TX bottom-with C. G. lead List Price... \$1.25



**950TR TRANSFORMER-TYPE TUBE-CHECKING ADAPTER**  
 Has self-contained filament transformer and voltage switch for testing all 10 to 30 volt tubes in any type 21 tube-checker socket. Can you check the 2Z5, 43, 48, 4Z3, 14, 17, 18, A22, A26, A28, A30, A32, A40, A48, AE, HZ50, BA1, 841, 25Z3, 90, 262A, 272A, etc. If not, you need the 950TR adapter. Direction and reading chart on base of adapter. Get yours now and be able to check all the new high filament voltage tubes. List Price... \$6.00  
 Servicemen's Discount... 25%  
 On orders amounting to \$10.00 List Price... 10%



**HERE'S THE DATA YOU WANT**

Send two 2¢ stamps for new booklet showing illustrated tube-socket connections of over 200 different types of tubes, data on rewiring obsolete set analyzers and using new tubes in place of old types. Includes catalog pages on all kinds of individual and composite sockets, speaker slugs, connectors, wound and unwound plug-in coils, coil winding data and S-W and B-C receiver circuit, etc.

**ALDEN PRODUCTS CO.**  
 Dept. R-11, 715 Center St.  
 BROCKTON, MASS.

The tools are cut to shape with a file, before hardening, of course.

In using the cutter the sockets are first laid out, and their centers spotted with a prick-punch. Then a 1/8-in. drill is used to bore a hole at the prick-punch mark, afterwards reborng the hole with a 1/4-in. drill. Finally, the pilot of the hole cutter is placed in the hole and the socket hole cut.

Some folks prefer a socket hole with a diameter of 1 1/4 in., while others want one 1 3/8 in.; I have split the difference with this tool and made it 1 5/16 ins. in diameter.

HENRY LARABY,  
 56 Maiden Lane,  
 Bridgeport, Conn.

## BOOK REVIEW

**LA TELEVISION ET SES PROGRESS**  
 (Television and Its Progress), by P. Hemardinquer; preface by A. Blondel. Published by Dunod, Paris, France. 5 1/2 x 8 1/2 ins.; 244 pages, deckle edge, 150 illustrations, paper covers.

One outstanding fault to be found with previous works on the subject of television was the biased manner in which they were prepared; there was obvious, an effort to "sell" a particular television system, or the author permitted his patriotism to overshadow his choice of material. In pleasant contrast with this state of affairs is "La Television et ses Progress" which, although written in the French language, contains a remarkably cosmopolitan review of the entire field of television.

Perhaps it is not too much to hope for an English version of this book. However, that should not prevent the ambitious technician gleaming what he may from this well-illustrated volume which, although written in French, is extremely instructive, as is indicated by the following review of the chapters.

(1) *The history and essential principles of television.* This chapter starts with a description of the electro-chemical picture transmission experiments of Bain and Blackwell, around the year 1850, and concludes with a discussion of the new Zworykin cathode-ray system of television.

(2) *The problems of television and its optical and electrical difficulties.* In this chapter the author clearly shows the reasons for numerous effects encountered in television reception and transmission.

(3) *The elementary operations of television.* Most readers of the volume will agree that this is the most interesting chapter. This due, particularly, to the lucidity with which the author handles the intriguing subject of the Kerr cell and Nicol prism in connection with the polarization of light.

(4) *The transmission and reception of television.* All the various types of studio arrangements followed in various countries are described, with particular reference to the technical features peculiar to each system.

(5) *Radiovision for the amateur.* The American reader of this book will be quite astounded at the wealth of information which the author has compiled concerning amateur television equipment based on many different television systems, and available in the countries to which they are indigenous.

(6) *Cathode-ray television.* It is of interest to observe that the author has devoted considerable space to the subject which is going to receive the greatest attention in the next two or three years. For, television by means of vacuum tube picture dissembling and recombining units appears to be the most logical system so far proposed; the advantages offered by, for instance, cathode-ray tubes are numerous, as the author shows in this chapter in which the latest ideas are described.

(7) *The Progress of television.* Internationally known pioneers in television tell the reader, in this concluding chapter, just what developments we may expect in the field of television within the next few years. Quotations include the opinions of Bartheleny, P. Brenot, Dauvillier, Edouard Belin, Marc Chauvierre, Rene Hardy, Van Dyck, Manfred von Ardenne, J. L. Baird, Hugo Gernsback, and V. K. Zworykin.

## Index to Advertisers

<b>A</b>	Acronox Corporation	300
	Allen Mfg. Co.	316
	Allied Radio Corp.	309
	American Radio Hardware Company	308
	American Red Cross	306
	American Technical Society	302
	Amperite Corporation	305
	Automote Mfg. Co.	298
<b>B</b>		
	Bud Speaker Company	315
	Burstein-Applebee Co.	309
<b>C</b>		
	Capitol Radio Engineering Institute	309
	Central Radio Laboratories	298
	Christell-Acoustic Labs.	298
	Clark Instrument Co.	298
	Claroast Mfg. Company	298
	Coast-to-Coast Radio Corp.	298, 311
	Coyne Electrical School	257
<b>D</b>		
	Deutschemann Corp., Tele	296
	Dumont Electric Co.	304, 311
<b>E</b>		
	Electrad, Inc.	307
<b>G</b>		
	Greepark Company	310
<b>H</b>		
	Hammarlund Mfg. Company	297
	Harrison Radio Co.	309
	Hoodwin Company, Clax	312
	Hygrade Sylvania Corp.	308
<b>L</b>		
	Leeds Radio Company	308
	Leotone Radio Company	297
	Lynch Mfg. Company	309
<b>M</b>		
	Midwest Radio Corp.	Back Cover
<b>N</b>		
	National Radio Institute	250
	National Union Radio Corp.	299
<b>P</b>		
	Pal Ko, Inc.	302
	Pemberton Laboratories	302
	Polk & Co., R. L.	308
	Popular Book Corp.	304
	Postal Radio Corp.	306
	Precision Resistor Co.	302
<b>R</b>		
	Racon Electric Co.	308
	Radio City Products Co.	306
	Radio & Television Institute	261
	Radio Training Company	320
	Radio Training Association	313
	Radelek Company	315
	RCA Cunningham Tube Corp.	305
	RCA Institutes, Inc.	298
	RCA Victor Co., Inc.	309
	Readrite Meter Works	Inside Front Cover
	Remington Rand, Inc.	311
	Hotel Royal	308
<b>S</b>		
	Saxology	306
	Shallross Mfg. Co.	253
	Shure Brothers Company	309
	McMurdo Silver, Inc.	Inside Back Cover
	Johnson Smith & Company	317
	Stewart Warner Corp.	302
	Supreme Instruments Corp.	312, 313
<b>T</b>		
	Taussig, Leo	309
	Tilton Mfg. Company	242
	Triplet Elec. Instrument Co.	301
	Truman Radio Shop	309
	Try Mo Radio Co., Inc.	309
<b>U</b>		
	Universal Microphone Co.	309
<b>W</b>		
	Webster Company, The	307
	Wellworth Trading Company	314, 315
	Westinghouse Elec. & Mfg. Co.	297
	Weston Elec. Instrument Corp.	295
	Wholesale Radio Service Co.	304

(While every precaution is taken to insure accuracy, we cannot guarantee against the possibility of an occasional change or omission in the preparation of this index.)

# BOYS! THROW YOUR VOICE



Into a trunk, under the bed or anywhere. Lots of fun fooling teacher, policeman or friends.

## THE VENTRILLO

a little instrument, fits in the mouth out of sight, used with above for Bird Calls, etc. Anyone can use it. Never fails. A 16-page course on Ventriloquism and the Ventrillo. All for 10c postpaid.

All Parts Necessary for Only 10c Runs on No. 5 Dry Battery

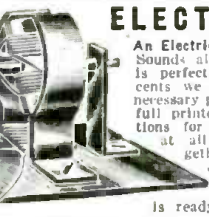

## ELECTRIC MOTOR

An Electric Motor for Only 10 cents. Sounds almost unbelievable but it is perfectly true. For ONLY 10 cents we send you all the parts necessary packed in a neat box with full printed and illustrated directions for assembling. No trouble at all putting the parts together. In fact it is FUN. Just follow a few simple instructions and in a few minutes the motor is ready to run. 10c postpaid.

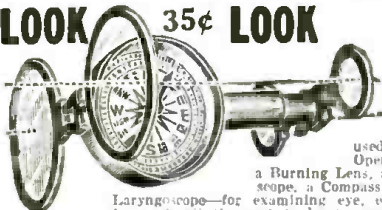

## LOOK 35¢ LOOK

## WONDERFUL INSTRUMENT

Greatest thing yet. Nine separate articles in one. Odd, Curious and interesting. Lots of pleasure as well as very useful. Can be used as a Magnifying Glass, Opera Glass, a Stereoscope, a Burning Lens, a Telescope, a Compass, a pocket Mirror, and a Laryngoscope—for examining eye, ear, nose and throat. It is worth all the cost to have even one of the most useful instruments in the eye. Folds flat and fits the pocket. Price, 35c, or 3 for \$1.00.



## LUMINOUS PAINT

Make Your Watches, Clocks, Etc., Visible by Night

The very latest discovery in the scientific world. Recently perfected. Practically unobtainable elsewhere. We have at last succeeded in producing this remarkable LUMINOUS PAINT, which, applied to the surface of any article, emits rays of white light, rendering it perfectly visible in the dark. THE DARKER THE NIGHT, THE MORE BRILLIANT IT SHINES. Quite simple to use. Anyone—you can do it. A little applied to the dial of your watch or clock will enable you to tell the time by night. You can coat the push buttons of switch plates of your electric lights, match boxes, and lanterns with the article; make your own Luminous Clocks, Luminous Boxes, etc. Bottles containing sufficient to coat several small articles. Price 25c. Larger size 50c and \$1.00 postpaid.

# BIG ENTERTAINER



180 Jokes and Riddles. 34 Magic Tricks, 54 Parlor Games. 73 Toasts, 15 Tricks with Cards. 50 Money-making Secrets. 10 Funny Readings, 3 Monologues. 21 Puzzles and Problems. 5 Comic Recitations. Cut-outs for Checkers and Chess, Dominoes, Fox and Geese, 9 Men Morris, Spanish Prison Puzzle, Game of Anagrams, etc. All for 15c postpaid.

## HYPNOTIZE

This book tells how. Explains all about Hypnotism, how to hypnotize, how to produce sleep, how to awaken a subject, medical hypnosis, hypnotism in diagnosis, how to hypnotize animals, illusions and hallucinations, auto suggestion, telepathy, etc. 27 fascinating chapters. A complete treatise on the subject. Sent postpaid—ONLY 10c Postpaid.



## PLAY PIANO IN ONE HOUR

With this new VAMPING BOARD. No teacher needed. Surprisingly simple. Place the Vamping Board upright over the piano keys, and vamp away to thousands of songs, ballads, waltzes, fox trots, race time, etc. No knowledge of music required. After using a few times the Board may be dispensed with entirely. Price 15c Postpaid.

## COMPLETE HYPNOTISM

200 pages. New! 100 lessons. 35c.

## GOOD LUCK RING

Very striking, quiet and unobtrusive. (Shine! Shine!) skilful and original designs. Two brilliant Swallow gem sparkles out of the eye. Said to bring good luck. Only 25c postpaid.

## 5-MINUTE HARMONICA COURSE

A new easy self-teaching method. Teaches how to play, to use the tongue, tremolo, fully illustrated. Price 15c postpaid.

## TELL YOUR OWN FORTUNE

With the aid of this dream book and fortune-teller. The key to your future. Will you be lucky in love? Successful in business? Will you be wealthy? Complete with directory of dreams with descriptions and correct interpretations, with easy numbers, fortunate days, weeks, division, and other data. Price 10c postpaid.

## 125 CARD TRICKS

and slight of hand. Contains all the latest and best card tricks as performed by celebrated magicians. With exposure of card tricks used by professional gamblers. Price 25c postpaid.

## PERFORMING SKELETON

A jointed figure of a skeleton 1 1/2 in. in height. Will dance to music and perform various gyrations and contortions while the operator may be some distance from it. Price 10c, 3 for 25c postpaid.

## FORTUNE TOLD BY CARDS

It is known how to tell fortunes with cards. Use the rings, crystal, etc. Take the meaning of any combination of every card. Nine different methods explained. Fully illustrated. Cramped full from notes cover with complete information on how to tell. Price 10c postpaid. No age accepted.

## HOW TO PITCH

Book contains lessons by leading pitchers, written in simple language. 56 illustrations. 25c postpaid.

## LATEST CATALOG

## JOHNSON SMITH & CO., Dept. 946, Racine, Wis.

A copy of our NEW CATALOG mailed on receipt of 10c, or the De Luxe Edition with cloth binding 25c. Bigger and better than ever. Only book of its kind in existence. Nearly 900 pages of all the latest tricks in magic, the newest novelties, puzzles, games, sporting goods, rubber stamp, unusual and interesting books, curiosities in seeds and plants, etc., unobtainable elsewhere. Remit by Cash, Money Order, Check or unused U. S. Postage Stamps, for all articles listed above. Canadian money, stamps and Postal Notes accepted at current rate of Exchange.

# SOLAR TELESCOPE—\$1.25 NEARLY 3 FEET LONG



The new Excelsior Solar Telescope is a large and serviceable instrument, nicely made and accurately fitted. When extended it is almost three feet in length, and when closed measures not quite twelve inches in length. Telescopes of this size usually sell for many times this price, but by importing them direct from a large European manufacturer, we are enabled to offer them to our customers for ONLY \$1.25 each, at which price they ought to sell readily. The lenses are well made, the sides are brass bound, and the four sections are perfectly fitted. Here is your chance to obtain a Telescope for a nominal sum. It will be sent postpaid to any address upon receipt of \$1.25 in any convenient form. Postage stamps accepted if more convenient.

## Blank Cartridge Pistol



Well made and effective; modelled on latest type Revolver; appearance alone enough to scare a burglar. Fires 22 Cal. Blank Cartridges obtainable everywhere. Price 50c, or better make and superior finish \$1.00. Blank Cartridges 50c per 100. Holster (Cowboy type) for Blank Cartridge Pistol 50c. Shipped by Express only. Cannot go by parcel post. 770 page Catalog of firearms, sporting goods, novelties, etc., 10c.

## MAKE YOUR OWN RADIO



Enjoy the concerts, baseball games, market reports, latest news, etc. This copy-righted book 'EFFICIENT RADIO SETS' shows how to make and operate inexpensive Radio Sets; the materials for which can be purchased for a mere trifle. Also tells how to build a short-wave Receiver for bringing in news stations, police calls, ships at sea, etc. ONLY 15c. postpaid.

## BAG O' TRICKS 15c



It is great fun mystifying your friends. Get this Bag O' Tricks and be the cleverest fellow in your district. Contains apparatus and directions for FOUR FIRST CLASS TRICKS, including the MAGIC PADDLE (mystify your friends by making match stick jump from one hole to the other), the TASTYLING CROSS TRICK, HINDU MYSTIC SQUARE TRICK, and the MYSTERIOUS RATTLING STICK TRICK. Full instructions with each trick. No skill required. Everything complete for 15c postpaid.

## SILENT DEFENDER



Used by police officers, detectives, sheriffs, night watchmen and others as a means of self-protection. Very effective. Easily fits the hand, the finger, the thumb. Useful in an emergency. Made of aluminum they are very light, weighing less than 3 ounces. Handy pocket size always ready for instant use. PRICE 25c each, 2 for 45c postpaid. Catalog 10c.

## WONDERFUL X-RAY TUBE

A wonderful little instrument producing optical illusions both surprising and startling. With it you can see what is apparently the bones of your fingers; the lead in a lead pencil, the interior opening in a pipe stem, and many other similar illusions. Price 10c, 3 for 25c.

## Electric Telegraph Set 15c

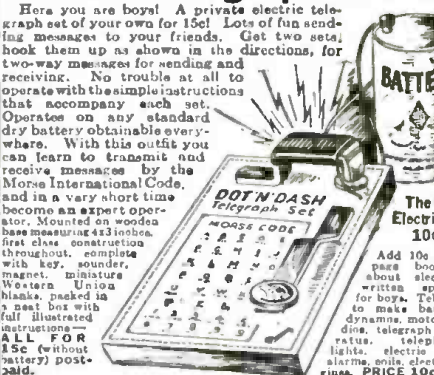

Here you are boys! A private electric telegraph set of your own for 15c! Lots of fun sending messages to your friends. Get two sets, hook them up as shown in the directions, for two-way messages for sending and receiving. No trouble at all to operate with the simple instructions that accompany each set. Operates on any standard dry battery obtainable everywhere. With this outfit you can learn to transmit and receive messages by the Morse International Code, and in a very short time become an expert operator. Mounted on wooden base measuring 4 1/2 inches. Complete throughout, complete with key, sounder, magnet, miniature Western Union blinks, packed in neat box with full illustrated instructions—ALL FOR 15c (without battery) postpaid.

## ITCHING POWDER

This is another good practical joke; the intense discomfort of your victims is everywhere. It is thoroughly enjoyable. All that is necessary to start the ball rolling is to deposit a little of the powder on a person's hand and the powder can be rubbed up to deposit rest. The result is a vigorous scratch, then some more scratch, and still some more. 10c box, 3 boxes for 25c or 75c per dozen. Shipped by Express only.

## NOVELTY FRENCH PHOTO RING



A classy looking ring, with imitation platinum finish, set with large imitation diamond. In the shank of the ring is a small microscopic picture, almost invisible to the naked eye, yet is magnified to an almost incredible degree and with astonishing clearness. There are pictures that should suit all tastes, such as bathing girl beauties, pretty French actresses in interesting poses, also views of places of interest in France, Panama Canal and elsewhere; others show Lord's Prayer or Ten Commandments in type. State wishes and we will try and please you. PRICE 25c, 3 for 65c, or \$2.25 per doz. postpaid.

## ANARCHIST BOMBS

One of these glass vials drops in the foot of people will cause more consternation than a limburger cheese. The smell entirely disappears in a short time. 10c per box, 3 boxes for 25c or 75c per dozen. Shipped by Express. Not Postpaid.

## SNEEZING POWDER

Place a very small amount of this powder on the back of your hand and blow it into the air, and watch them sneeze without knowing the reason why. It is most amusing to hear their remarks, as they never suspect the real source, but think they have caught it from someone else. Between the laughing and sneezing you yourself will be having the time of your life. For parties, political meetings, car rides, or any place at all where there is a gathering of people, it is the greatest joke out. PRICE 10c, 3 for 25c, 75c per dozen. Shipped by Express. Not Postpaid. 770 page Novelty Catalog 10c.

## COMICAL MOTTO RINGS

Lots of harmless fun and amusement wearing these comical motto rings. Made of platinum finish (to resemble platinum), with wording on engraved, illustrated. Price 25c, aa. Postpaid.

## MAGIC MADE 250 MAGIC TRICKS

An excellent little book containing 250 Parlor Tricks, tricks without cards, baraballs, eggs, rings, glasses, etc. So simple that a child can perform them. Profusely illustrated. Sent postpaid to any address for only 10c. 3 copies for 25c postpaid.

ADDRESS ORDERS FOR ALL GOODS ON THIS PAGE TO JOHNSON SMITH & CO. DEPT. 946 Racine, Wis.

# The Radio-Craft Library Series covers accurately every branch of Radio—and thoroughly, too

Presented on this page are the new books of the RADIO-CRAFT LIBRARY—the most complete and authentic set of volumes treating individually, important divisions of radio. Each book has been designed to give radio men the opportunity to specialize in one or more of the popular branches of the industry. The material contained

in these books will increase your knowledge; you will find them a real help in your work and they will contribute to your money earning capacity. Read these books during your spare time at home. The authors of these books are well-known to everybody. Each one is an expert radio man; an authority on the subject—each is thoroughly

familiar with the field which he represents. This is perhaps the first real opportunity that you have ever had to build a radio library of books that are authentic, right-up-to-the-minute and written so that they are easily digested and clearly understood. Mail coupon below for your books.

## TO THE RIGHT WILL BE FOUND A SHORT RESUME OF EACH BOOK



Book No. 1

### Radio Set Analyzers

And How to Use Them

With Full Instructions and Descriptions of Set Analyzers, Tube Checkers, Oscillators, Etc.

By L. VAN DER MEL

This book explains thoroughly the operation of set analyzers, tube checkers, oscillators and other testing equipment. For every radio man this book is extremely helpful. It covers every phase of testing and gives you valuable short cuts; completely illustrated with photographs and diagrams to facilitate the use of modern testers. Recently reprinted.

Book No. 2

### Modern Vacuum Tubes

And How They Work

With complete Technical Data on All Standard and Many Special Tubes

By ROBERT HERTZBERG

MODERN VACUUM TUBES describes the fundamental theory which is the basis of all vacuum tube operation, and goes progressively from the simplest two-element tubes right up to the latest pentodes and thyatrons. It is written in clear, simple language and is devoid of the mathematics which is usually so confusing. Valuable reference charts and characteristic curves are to be found, also diagrams of sockets and pin connections.

Book No. 3

### The Superheterodyne Book

All About Superheterodynes

How They Work, How to Build and How to Service Them

By CLYDE FITCH

There is no more fascinating a subject in the large array of radio circuits than the famous superheterodyne circuit. Whether you are a Service Man or experimenter, first-hand knowledge about the construction of superheterodyne receivers is very important. The book on Superheterodynes gives underlying principles of their construction, right from the very first set made.

Book No. 4

### Modern Radio Hook-Ups

The Best Radio Circuits

A Complete Compendium of the Most Important Experimental and Custombuilt Receivers

By R. D. WASHBURNE

It is fascinating to the experimenter, or even to the up-to-date Service Man, to take a commercial set and to change it into one using a famous hookup that is not found in any manufactured set. Many excellent circuits have never been commercialized, but limited only to home set builders. Thousands of these popular circuits have been requested from time to time and in this book we have included over 150 circuits, which include the famous Peridyne, Cash-Box A.C.-D.C. Set and others.

Book No. 5

### How to Become a Radio Service Man

How to Get Started and How to Make Money in Radio Servicing

By LOUIS MARTIN

The ambition of many men in radio today is to become a first-grade Service Man. It is not as difficult as one might believe, but it cannot be done in a few short months. Following very carefully the advice of Mr. Martin, who has dealt with the problems of thousands of Service Men, this book deals very carefully with the essential stages in the preparation for qualifying as a Service Man.

Book No. 6

### Bringing Electric Sets Up to Date

With Pentodes, Multi-Mus, Dynamic Speakers—Complete Information How to Modernize A. C., D. C. and Battery Operated Receivers

By CLIFFORD E. DENTON

In this country there are over ten million electrically operated receivers that could be modernized—by placing in them new type tubes, new speaker equipment and other modern improvements. This business of improving old sets can go to the experimenters and Service Men if they will quickly jump into action.

Book No. 7

### Radio Kinks and Wrinkles

For Service Men and Experimenters

A Complete Compendium on the Latest Radio Short-Cuts and Money-Savers

By C. W. PALMER

It often becomes necessary for experimenters and Service Men to call upon their memory for some short cut or radio wrinkle that will solve a problem quickly. In business, "short cuts" mean time and money saved, and to the Service Man "time saved" means money earned.

Book No. 8

### Radio Questions and Answers

A Selection of the Most Important of 5,000 Questions Submitted by Radio Men During the Course of One Year

By R. D. WASHBURNE

There have been collected a wide variety of questions which have come into our editorial offices during the past two years, and only those whose answers would benefit the majority of men engaged in radio have been incorporated in this amazing question and answer book. A tremendously long list of topics is treated.

Book No. 9

### Automobile Radio and Servicing

A Complete Treatise on the Subject Covering All Phases from Installing to Servicing and Maintenance

By LOUIS MARTIN

Automobile radios are up and coming, and someone has to service them properly. It therefore behooves you to read this immensely important new book on the art of Automobile Radio. The book is concise, and full of illustrations, photographs, diagrams and hookups.

A few of the really interesting chapters: Introduction; Automotive Radio Installations; Complete Descriptions of Commercial Automotive Receivers; Servicing Automotive Receivers; The Ignition System; General Service Considerations; Effects of Temperature on Power Supply; Conclusion.

Book No. 10

### Home Recording and All About It

A Complete Treatise on Instantaneous Recordings, Amplifiers, Commercial Machines, Servicing, etc.

By GERDGE J. SALIBA

If there is one subject that is fascinating to every radio man, it is that of Home Recording. Of course, this volume is not all on "Home" recording, but the information contained therein is important to commercial radio men, studio operators, engineers and others interested in this phase of radio.

The art of recording and reproducing broadcast selections is becoming more important every day to radio men, experimenters and Service Men. Equipping dance halls, auditoriums, churches, restaurants and homes with public address systems and amplifiers brings many extra dollars, and often an excellent income.

Book No. 11

### Point-to-Point Resistance Measurements

The Modern Method of Servicing Radio Receivers

By CLIFFORD E. DENTON

Of the difficult problems which Service Men face today when repairing receivers, the greatest is that of replacing proper resistance values in sets. This task becomes even more difficult when the values of resistors are unknown, and manufacturers of many standard sets do not pass this information on to Service Men. In this new book radio men will find the information needed to quickly place a receiver in normal operating condition. This book cuts in half the time usually required to adjust the average set.

Sufficient space has been devoted to the elementary problems and the theory of electricity as it is applied to resistance measurements so that the Service Man will have a comprehensive idea as to how to overcome this problem. How you will find a partial list of the contents which will appear in this new book.

INTRODUCTION; Advantages of Resistance Measurement Method of Servicing for Radio Work; Basic Principles; Methods of Resistance Measurement; Resistors in Radio Receivers and Amplifiers; Point-to-Point Resistance Measurements in Typical Radio Set using Ohmmeter; Resistance Measurements using Modern Tester; Routine Testing where Circuit Diagram is Available and where Resistances are Known; the Relation of Voltage-Testers Methods to Resistance Measurement; APPENDIX; Resistance Charts etc.

## ALL BOOKS UNIFORM

The books in the new RADIO-CRAFT LIBRARY are all strictly up-to-date, and written by men who know their subjects. The volumes are all uniform size, 6x9 inches, and contain on an average of 50 to 120 illustrations. Each book is printed on fine book paper and no expense has been spared to make it an outstanding value, for its editorial contents as well as from the mechanical standpoint.

## Big Discount to You

In order to make it possible for everyone to buy these books, the fifty (50) cent price has been made uniform for all volumes. You can buy these books separately, but you should take advantage of our special offer:

**When Five (5) Books or More Are Ordered**

**Deduct 20% from Your Remittance**

Simply fill in the coupon at left, and mail it to us together with your remittance. Checks, stamps or money orders accepted.

## Clip Coupon and Mail Today!

GERNSBACK PUBLICATIONS, INC., 96-98 Park Place, New York, N. Y.

I have circled below the numbers of books in the RADIO-CRAFT LIBRARY, which you are to send me, and have deducted 20% for ordering five (5) books or more. I have included my remittance in full, at the price of 50c each, when less than five books are ordered.

The amount of my remittance is.....(Stamps, checks or money orders accepted.)  
Circle numbers wanted: 1 2 3 4 5 6 7 8 9 10 11

Name ..... Address .....

City ..... State ..... RC-11-33





# \$50,000 SPEAKER CLEARANCE SALE!

**SPECIAL - SALE - FEATURE**

## FARRAND INDUCTOR DYNAMIC



The Ideal Short Wave Receiver Speaker:  
Eliminates Hum and Line Noise;  
Draws Less Current;

Absolutely Genuine Farrand:  
Compact in Size;  
Brings in the Very Weak Short Wave Stations;

Do not confuse this model with the various similar types on the market, posing as Farrands. This is the true Farrand Inductor Dynamic. Its adaption to Short Wave Radio Receivers has proven a popular step. The most inaudible stations are brought in with remarkable clearness without the customary noise and hum of regular dynamic speakers. Has two magnets parallel to each other with a bracket placed between them to facilitate mounting. Overall 9".

**\$3.95**

### BOSCH SPEAKER CABINET



Will accommodate any magnetic or dynamic chassis up to 10" in diameter. A beautiful walnut cabinet artistically and expensively finished. It was built by one of the foremost manufacturers of cabinets. Grill contains a gold bronze cloth for contrasting color scheme.

Dimensions 12½" high, 12" wide, 10" deep.

Price ..... **\$1.75**

*Limited Quantity!*

### GENUINE R. C. A. MAGNETIC CHASSIS



This chassis is the identical one used in the R.C.A. 100A-100B and 103 Speakers which list for as high as \$35.00. Note built-in output transformer which permits use of 450 volts without distortion, rattling or blasting. Generous oversized magnet. The thick armature is accurately centered, the sturdy metal frame is lined with a special self-baffling fabric, greatly improving acoustic properties of this sensational speaker. Note the corrugated surface of the cone, an exclusive feature—enhances perfect reproduction qualities considerably; most compactly made; 9" outside diameter, 4½" deep overall.

Price ..... **\$2.75**

### FARRAND 12" MODEL INDUCTOR DYNAMIC

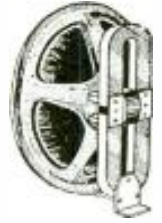

The 12" models have two magnets standing upright, with a bracket on the bottom to ease mounting. Dimensions of the 12" model: 12" high and 6½" deep. (12" Model)

Our Price ..... **\$5.95**

### JENSEN Model D-7, A.C. DYNAMIC



Widely used as an additional speaker in many homes, as well as on public address systems. Will handle an enormous amount of volume without distorting or rattling. Equipped with a 250 rectifier tube. The speaker measures 12½" high, 11¾" wide, and 7 7/32" deep. Baffle opening required, 10". Supplied complete with tube.

A.C. Model ..... **\$8.95** D.C. Model ..... **\$6.95**

### OXFORD A.C. and D.C. CONCERT



11½" concert model. Three point suspension balanced cone type. A.C. uses 280 rectifier. D.C. models have a field resistance of 2,500 ohms. Output transformer may be had for single or push pull output tubes.

A.C. with Tube ..... **\$5.75**  
D.C. Model ..... **\$4.50**

### PEERLESS A.C. and D.C. DYNAMIC SPEAKER CHASSIS



Adaptable for the most powerful amplifier. Equally suited for use with any receiver employing the average type of audio amplification system using as low as 90 volts "B" current. D.C. model has a 1,000 ohm field and a push-pull output transformer; A.C. model uses a dry rectifier system with a hum condenser for minimum A.C. hum.

Dimensions—12" high, 8" deep.

A.C. Model, Price, **\$8.95**; D.C. Model, Price, **\$6.95**

6 Volt. Price ..... **\$7.95**

*Price Going Up. Buy Now!*

### Stromberg-Carlson MAGNETIC PICKUP



The season for public address amplification is here. For perfect tonal quality and service insist on a genuine STROMBERG-CARLSON PICKUP. Little has to be said about it—Stromberg-Carlson quality is known the world over. Price includes a Stromberg-Carlson Head, Arm, Matching Transformer, Pickup Plug and 20-Foot Insulated Extension Cord.

**BUY NOW! This Low Price For a Short Time Only!**

Price Complete ..... **\$5.50**

### OXFORD A.C. or D.C. Auditorium DYNAMIC



11" auditorium model. Takes a baffle with a 12½" opening. Oversize frames with extra gauge wire in the field coil, which gives the speaker higher field strength and permits greater energization. D.C. model has a 4,000 ohm field which can be energized from the power packs of amplifiers or from 110 volt D.C. line.

A.C. with 280 Tube ..... **\$9.95**  
D.C. Model ..... **\$7.95**

## GREN PARK COMPANY

**245 Greenwich St. Dept. RC New York, N. Y.**

All orders are F. O. B. New York, and subject to prior sale. Terms: A deposit of 20% is required with every order. Balance may be paid on delivery. Deduct 2% if full amount is sent with order.

**DO NOT SEND FOR CATALOG**

# RTC's Big November Specials

Every month we list on this page a few STAR\* items which are not listed in our catalog. These are all specials on which the quantities on hand are not sufficient to catalog them. *Once sold out, no more can be had. ORDER NOW—TODAY.*



No One in Radio Undersells Us!

**STOP SHOPPING**—the lowest prices are right on this page. *No one undersells us.* We meet any price on any new merchandise. Order direct from this page and save money. 100% satisfaction on every transaction. Take advantage today of these special offers.

## ★ "FARADAY" 7 TUBE SCREEN-GRID RADIO RECEIVER

Complete with Full Dynamic Speaker  
ONLY 100—NO MORE WHEN GONE

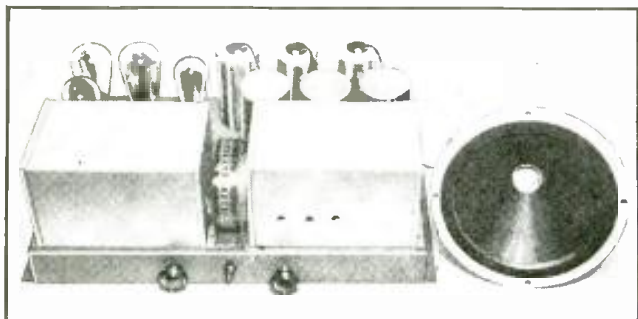

If ever there was a greater value than this before, we have yet to see it. The selectivity and sensitivity of this 7 tube receiver, due to its 3 tuned stages are just as sharp as those of a superheterodyne receiver. The construction of this set is best described as "Standard." Its circuit is none other than the "good-old-stimula" T. R. F. type which is the most fool-proof ever designed. It incorporates two stages of tuned R. F. amplification using type 23 screen-grid tubes, a type 24 push-pull detector, a single stage of type 27 A. F. voltage amplification and finally a push-pull stage using 2-45 tubes. The set is sold complete with a matched, full dynamic speaker.

Tuning is extremely simple. The knob on the left is a combination volume control and power switch. The knob on the right is the station selector. The toggle switch in the center enables you to control the tone from high treble to deep bass. Coils, tuning-condenser-range, filter bank, filter choke, bypass condensers, etc. are all thoroughly shielded. The chassis itself is made of heavy gauge metal.

**This receiver is not the mid-type.** It is a full set of solidifying qualities which are not found in the miniature sets. The set is fitted with a 250 volt, 500 watt and high am R. F. transformer, together with metal wiring and filtering coils of high sensitivity. Despite the fact of its tubular arrangement of controls, it is a most compactly designed set. It is the only 7 tube set in push-pull arrangement at such a low price.

Here is an excellent opportunity for a radio bargain. There are little over 100 of these receivers left and as this low price is found, it is not very long before it will be sold out. The model is "do not delay—order today." Its coils are type 72 and B. 121\* also covered. Embodies the following tubes of 24, 127, 245 and 1280. All high grade parts such as very good capacitors. Character volume control, etc. are used.

No. SP-2001 "Faraday" 7 Tube Screen Grid T. R. F. Receiver including dynamic speaker but less tubes  
**YOUR PRICE \$11.95**

## BUILD THE "NEW DEPENDABLE" TUBE TESTER

Sold Either Wired or in Kit Form

Here indeed is your opportunity to build one of the most tube checkers ever designed—an instrument which is MODERN in every sense of the word. Will test all the latest type tubes, including those with 7 AND 8 PRONGS—DIRECTLY—without the use of a "single adapter."

The "NEW DEPENDABLE," despite its high degree of accuracy, is extremely simple to operate. Both plates of the 80-82, 83 and other rectifier tubes are readily tested without the use of a "second plate" button. The instrument employs a high-grade, PARASYNAL TYPE, MOVING-COIL METER, insuring thereby extreme accuracy. This instrument will check more than 120 different tubes and even those which have not as yet been placed on the market. The tube tester is amply guarded against tube "shorts," which condition is indicated by the flashing of a small pilot light. All component parts are mounted on a beautifully etched panel and the entire instrument placed in a sturdy constructed, leatherette covered, carrying case. For operation on 105-125 volts, 50 and 60 cycles, A.C. This instrument is available either in kit form or completely wired and tested, ready to use. Shipping weight 9 lbs.

NO. 303 "New Dependable" Tube Tester. NO. 303 A "New Dependable" Tube Tester completely wired and tested.  
**YOUR PRICE \$18.73** **YOUR PRICE \$14.73**



## EXTRA SPECIAL Baird Universal Short Wave and Television Receiver

Seven Tubes—15 to 500 Meters

★ **Only 20 at This Price**



This is the same receiver which has been sold for \$20. It is a receiver which will test all the short wave bands of the world. It will also receive BROADCAST, TELEVISION, SHORT WAVE and BROADCAST BROADCASTS AS WELL. In other words it will receive practically everything which is broadcast in the world. This receiver is the most advanced in its class and is a television receiver for home use. It is a most complete and accurate receiver. It is a most complete and accurate receiver. It is a most complete and accurate receiver.

used in conjunction with Baird Television or any other television set. It is a most complete and accurate receiver. It is a most complete and accurate receiver. It is a most complete and accurate receiver. It is a most complete and accurate receiver. It is a most complete and accurate receiver.

LIST PRICE \$80  
No. 35 Baird Universal Short Wave and Television Receiver  
**YOUR PRICE ONLY \$22.48**

## NEW READRITE MODEL 710 ANALYZER

TESTS LATEST TYPE 6 AND 7 PRONG TUBES

NINE METER SCALES AVAILABLE

This new Readrite precision instrument, which tests every type of vacuum tube, is built for serious work. It has a set of 20 plates of design, its own set of 20 meters of range, and its own set of 20 meters of range. It has a set of 20 plates of design, its own set of 20 meters of range, and its own set of 20 meters of range.

The Model 710 is an extremely compact device. The only side dimension of the entire case is only 7 1/2 by 7 1/2 inches. The analyzer consists of a 120 V. transformer, a C.A. amplifier and a full set of 20 meters of range. The C.A. amplifier has four ranges: 0 to 10, 0 to 50, 0 to 100 and 0 to 200 volts. The analyzer has three ranges: 0 to 10, 0 to 100, and 0 to 200 volts. The analyzer has three ranges: 0 to 10, 0 to 100, and 0 to 200 volts.

CONVENIENT SELECTOR SWITCH—The instrument is equipped with a selector switch which can be set for any of the 20 meters of range. The selector switch can be set for any of the 20 meters of range. The selector switch can be set for any of the 20 meters of range.

TEST PENTODES—MULTI-MUS' 57's and 58's—60 RECTIFIERS, ETC.—This instrument is furnished with a set of 20 meters of range. The instrument is furnished with a set of 20 meters of range. The instrument is furnished with a set of 20 meters of range.



Model 710 Analyzer. List Price, \$27.50.  
**YOUR PRICE \$16.17**

**FREE RADIO AND SHORT WAVE TREATISE**

Available now of the opportunity to receive this FREE TREATISE of 116 solid pages of useful information, radio items, diagrams and illustrations. NOT found in any other catalog. NOT found in any other catalog. NOT found in any other catalog.

HERE IS A PARTIAL LIST CONTENTS

Fundamental Principles of Radio—Ohm's Law—Discussion of New Tubes—Constructing a Triple-Twin Amplifier—All about Superheterodynes—Eliminating Man-Made Static—Constructing a Two-Tube Short-Wave "Globe-Trotter" Receiver—\$3.00 Prize Suggestions—Radio Kinks, etc., etc.

WRITE TODAY. Enclose 4 cents for postage. Treatise sent by return mail.

Over 100 New Hook-Ups, Etc. 1000 Illustrations.

WE ARE A WHOLESALE HOUSE AND CAN NOT ACCEPT ORDERS FOR LESS THAN \$3.00. If C.O.D. shipment is desired, please remit 20% remittance, which must accompany all orders. If full-cash accompanies orders, deduct 2% discount. Send money order—certified check—U. S. stamps.

**ORDER FROM THIS PAGE** You will find special prices from time to time, in this magazine. Get our big FREE catalog for the greatest Radio Bargains. Should you wish goods shipped by parcel post, be sure to include sufficient extra remittance for same. Any excess will be refunded.

Radio Trading Company 102 Park Place New York, N. Y.



McMurdo Silver now presents

# MASTERPIECE II



Designed especially for Admiral Byrd,

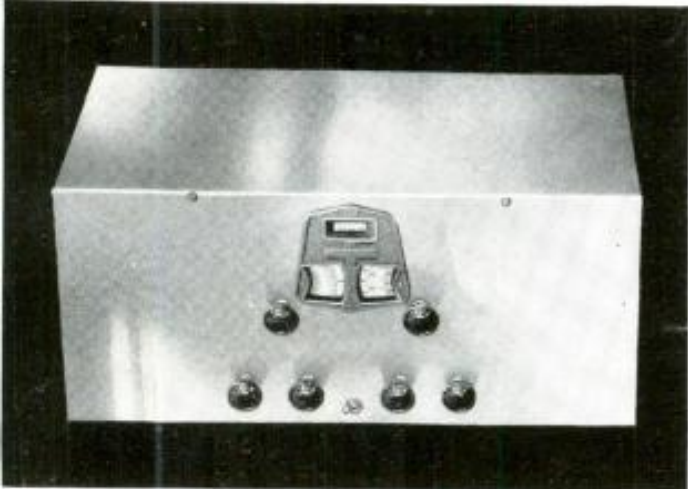

from specifications developed in collaboration with the research and engineering departments of Harvard and \*another great eastern University.

Admiral Richard E. Byrd, U.S.N., asked Dr. McCaleb of Harvard University which radio receiver would be best for his next Antarctic expedition.

In substance, Dr. McCaleb replied, "McMurdo Silver's Masterpiece, with certain additions."

Immediately, the engineering department of Harvard made certain suggestions to Mr. Silver, as did the engineering research department of another great eastern university, to produce, for Admiral Byrd, the greatest, most complete, most thoroughly able all-wave radio receiver the world has ever seen. Masterpiece II is the result.

The specifications of Masterpiece II, as you can readily see, promise a quality and extent of performance often dreamed of, but never seriously considered as either probable or possible of attainment. Yet, Masterpiece II actually meets them, to the letter, and its performance, very conclusively asserts the fact that an entirely new era of transoceanic radio reception has been born.

Duplicates of Masterpiece II . . . exact duplicates of the very receiver that is going into the Antarctic with Admiral Byrd, are now available.

A completely descriptive, fully illustrated book will gladly be sent upon receipt of the coupon below.

\*Name on request. Neither this university nor Harvard has a commercial interest in McMurdo Silver, Inc.

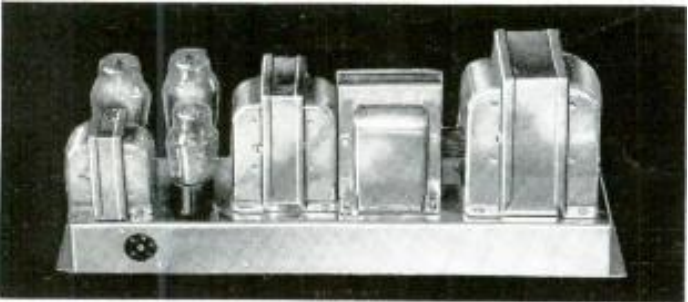

## BRIEF SPECIFICATIONS

Wave length Range 10 to 570 meters or 520 to 30,000 kc. Four position wave change switch.

(External unit extends range from 700 to 2000 meters.)

Tuned R. F. stage on both Broadcast and entire Short Wave range yet single dial tunes the receiver. Greatly improves signal-noise ratio on 12,000 mile reception.

Band-spread tuning on short waves. Makes short wave tuning actually easier than broadcast tuning.

3 air-tuned intermediate stages. Most accurate intermediate amplification ever developed.

Sensitivity better than 1/4 micro-volt absolute average.

Inter-station noise suppressor adjustable to exact location requirement.

Automatic volume control holds all stations 20 microvolts and up at constant volume to the ear.

Selectivity absolute 9 Kc. for Europe, better than U. S. needs (21 Kc. wide 10,000 times down).

Fidelity perfect over 30 to 4,000 cycle audio range.

Undistorted power output, 15 watts. Automatic and manual tone controls.

Special impregnation for tropical climates.

Built-in beat oscillator for easy finding of S.W. and weak broadcast stations.

Chromium plated steel shielding case eliminates need for cabinet.

10 day trial in your home. Open-and-shut guarantee. Money back instantly if you are not absolutely satisfied—no questions asked.

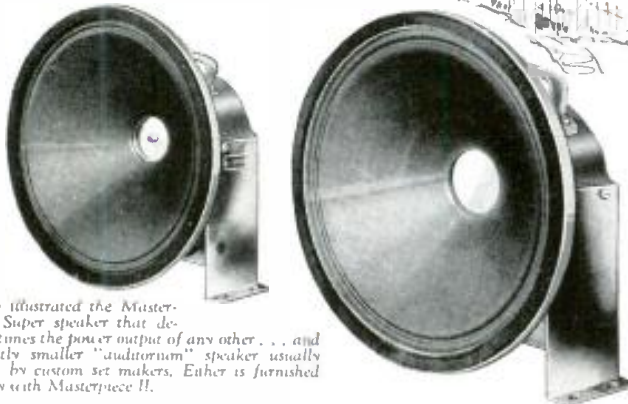

Here are illustrated the Masterpiece II Super speaker that develops 4 times the power output of any other . . . and the slightly smaller "auditorium" speaker usually furnished by custom set makers. Either is furnished optionally with Masterpiece II.

**McMURDO SILVER, Inc.**  
1735 BELMONT AVENUE - - - CHICAGO, U. S. A.

McMurdo Silver, Inc., 1735 Belmont Ave., Chicago, U.S.A.  
Send me full technical information on Masterpiece II.

Name .....  
Street.....  
Town ..... State .....



**Never Seen Equal**  
 "Logged several Central American and Mexican stations, short and long wave. Get FYA, France. Never seen anything to equal this new Midwest-16 for tone fidelity and consistent sensitivity."—T. N. Stewart, Vero Beach, Florida.



**Beyond Expectations**  
 "You certainly know how to build All-Wave Radios. I am pleased beyond all my expectations; have been listening for two hours to GSB in England, 12RO, and Pontoise, France."—Dayton H. Lasher, 287 Sylvan Ave., Waterbury, Conn.



**No Other Set Compares**  
 "The Midwest 16-Tube Radio is all you said and more (a world-wide receiver). I don't believe there is another set on the market today with the tone and selectivity of a Midwest 16-Tube Radio."—Mr. C. L. Gietl, 415 E. S. Grand Ave., Springfield, Ill.



**Fine Results**  
 "I am well pleased with the Midwest-16 and have had some fine results with it. Sunday afternoon we were listening to a Rugby game between Ireland and England, being broadcast from London."—B. J. Hart, 41 West St., Cromwell, Conn.

**THOUSANDS ARE Enthusiasing OVER THIS**

# Amazing New SUPER Deluxe 16 Tube ALL-WAVE Radio

**9 TO  
 2,000 METERS**

**30  
 DAYS  
 FREE  
 TRIAL**

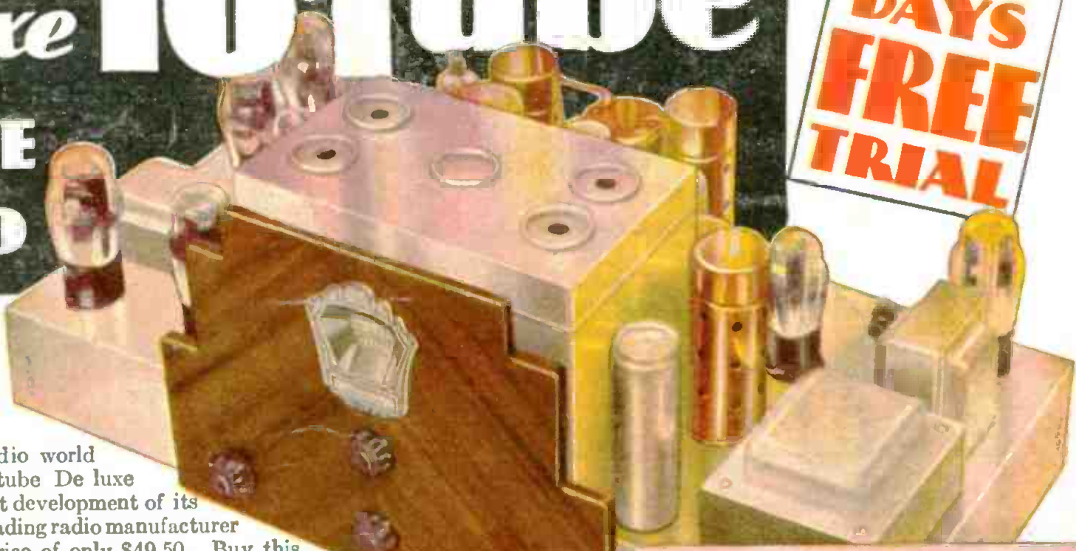

## World Wide Reception

**M**IDWEST startles radio world by offering this 16-tube De luxe ALL-WAVE radio... finest development of its 14 years of experience as leading radio manufacturer... at sensationally low price of only \$49.50. Buy this bigger, better, more powerful, clearer-toned radio... direct from Midwest Laboratories... at a positive saving of 30% to 50%. Brings in broadcasts from stations 10,000 miles and more away. Gives complete wave length coverage of 9 to 2,000 meter (33 megacycles to 150 KC).

This powerful, super-selective, radio has FIVE distinct wave bands... ultra short, medium, broadcast and long... putting whole world of radio at your finger tips. Now listen in on all U. S. programs... Canadian, police, amateur, commercial, airplane and ship broadcasts... and world's finest stations as: DFA Nauen, Germany—REN, Moscow, Russia—EAG, Madrid, Spain—12RO, Rome, Italy—VK2ME, Sydney, Australia. Never before so much radio for so little money. Don't buy any radio until you learn about this greatest of radio values. Send today for money-saving facts!

**TERMS  
 AS LOW AS  
 \$5.00  
 DOWN**

**WORLD'S GREATEST  
 RADIO VALUE**

**\$49.50**  
 with  
 New  
 Deluxe Auditorium Type  
**SPEAKER**

We will send you copies of letters like those illustrated at top of page. They'll convince you that Midwest radios are sensational values! They prove you can order your Midwest radio by mail with as much satisfaction as if you were to select it in our great radio laboratories.



**NEW STYLE CONSOLES**  
 The new, big Midwest catalog shows a complete line of beautiful, artistic, de luxe consoles... in the new modernistic designs... and priced to save you 30% to 50%. Hand made by Master Craftsmen, they lend distinction and dignity to any home. Mail coupon today.

## 40 NEW 1934 FEATURES

Try this Midwest radio... in your own home... for thirty days before you decide. See for yourself the 40 new 1934 features that insure amazing performance. For example—Automatic SELECT-O-BAND (exclusive with Midwest), simplifies short wave tuning, instantly pointing out the wave length of the station. Other features include: Amplified Automatic Volume Control, New Type Tubes, 16 Tubes, Balanced Unit Superheterodyne Circuit, Velvety Action Tuning, Super Power Class "A" Amplifier, 29 Tuned Circuits, New Duplex-Diode-High Mu Pentode Tubes, No-Image Heterodynes, Full Rubber Floated Chassis, Variable Tone Blender, Centralized Tuning, 7 KC Selectivity, New Thermionic Rectifier, Totally scientifically shielded (coils and switch catascumbed), etc. These and many additional features are usually found only in sets selling from \$100 to \$150.

## DEAL DIRECT WITH LABORATORIES

Increasing costs are sure to result in higher radio prices soon. Buy before the big advance... NOW, while you can take advantage of Midwest's amazingly low prices. No middlemen's profits to pay! You save from 30% to 50% when you buy direct from Midwest Laboratories—you get 30 days FREE trial—as little as \$5.00 down puts a Midwest radio in your home. Satisfaction guaranteed or your money back! FREE catalog shows sensational radio values. Write TODAY!

**SAVE  
 UP TO 50%**

Sign and mail coupon... or, send name and address on postal card... NOW!

## RUSH THIS COUPON FOR AMAZING 30-DAY FREE TRIAL OFFER AND NEW 1934 CATALOG

MIDWEST RADIO CORP.,  
 Dept. 312  
 Cincinnati, Ohio.

**AGENTS!**  
 Make Easy  
 Extra Money  
 Check Here for Details

Without obligation on my part send me your new 1934 catalog, and complete details of your liberal 30-day FREE trial offer. This is NOT an order

Name.....  
 Address.....  
 City..... State.....

**MIDWEST RADIO CORP.**  
 DEPT. 312 — CINCINNATI, OHIO, U. S. A.  
 Established 1920 Cable Address Miraco, ABC 5th Edition